



ARGENT H5 **RGB** 7.1

Surround Gaming Headset User Guide



PAGE 04

CONNECTING THE HEADSET

● Connecting via USB Port	-----	05
● Connecting via 3.5mm Port	-----	08
● Using The Control Box (Game/Chat Balance)	-----	10
● Using The Control Box (DTS 7.1 Surround Sound)	-----	11
● Setting up with Discord	-----	12

PAGE 13

TT iTAKE INSTALLATION

PAGE 16

FUNCTIONS AVAILABLE ON THE LIGHTING EFFECTS PAGE

PAGE 18

LIGHTING EFFECTS OVERVIEW

● Static	-----	19
● Pulse	-----	23
● Blink	-----	27
● Spiral Rainbow	-----	31
● Spectrum Cycling	-----	35
● Raindrop	-----	36
● Snake	-----	38
● System Temperature	-----	40



PAGE 41	FUNCTIONS AVAILABLE ON THE SPEAKER PAGE	
PAGE 43	FUNCTIONS AVAILABLE ON THE MIC PAGE	
PAGE 45	FUNCTIONS AVAILABLE ON THE EQUALIZER PAGE	
PAGE 47	FUNCTIONS AVAILABLE ON THE SETTINGS PAGE	
PAGE 49	DTS SOUND UNBOUND INSTALLATION	
	● Setup Instructions	----- 48
	● Enable DTS Headphone:X	----- 51

| Chapter 1 : CONNECTING THE HEADSET



Setting Up With PC :

Plug USB control box connector into your PC. The [Hardware found] notice will appear.

Playback Device Settings Step 1 :

Right click speaker icon -> Select Open Sound settings -> Select Sound control panel.

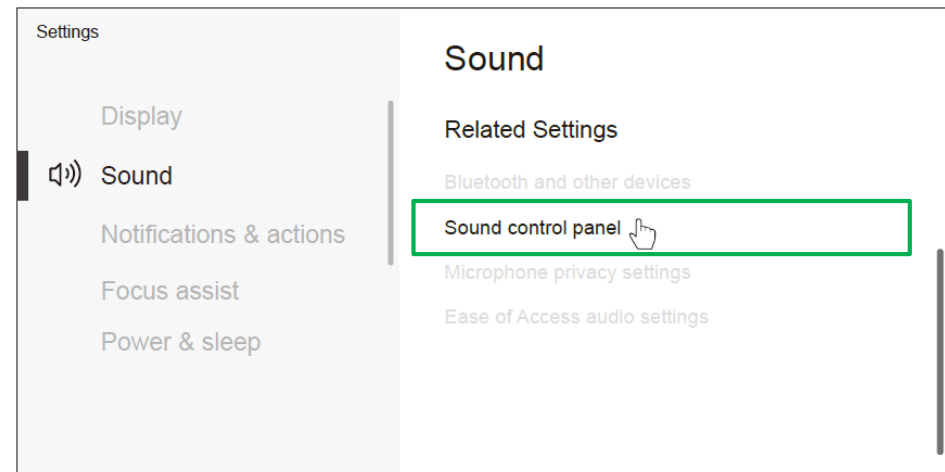
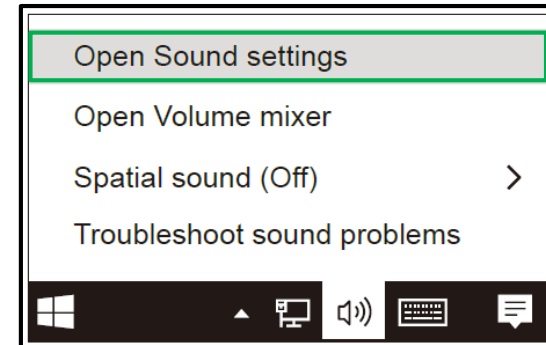
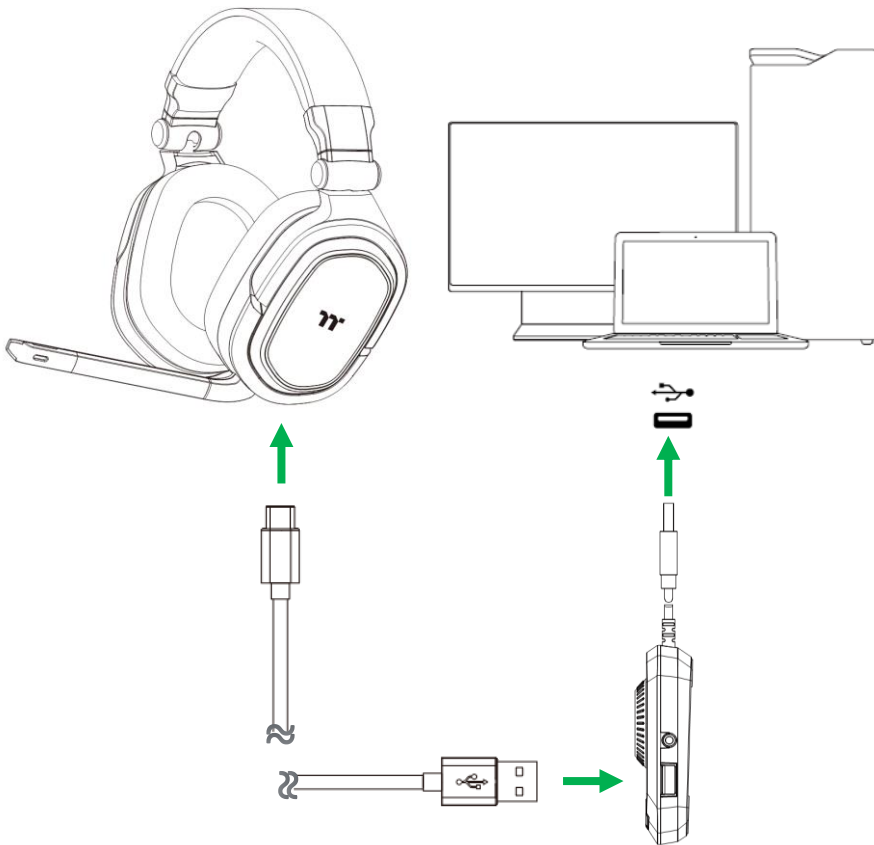



Playback Device Settings Step 2 :

Set Default Device to "Headphones".

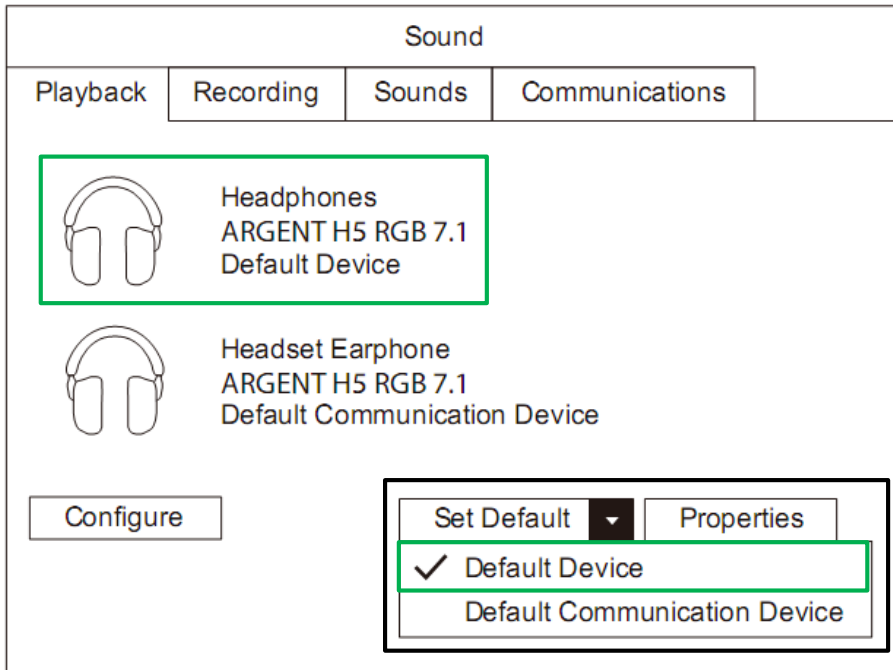

Playback Device Settings Step 3 :

Set Default Communications Device to "Headset Earphone".

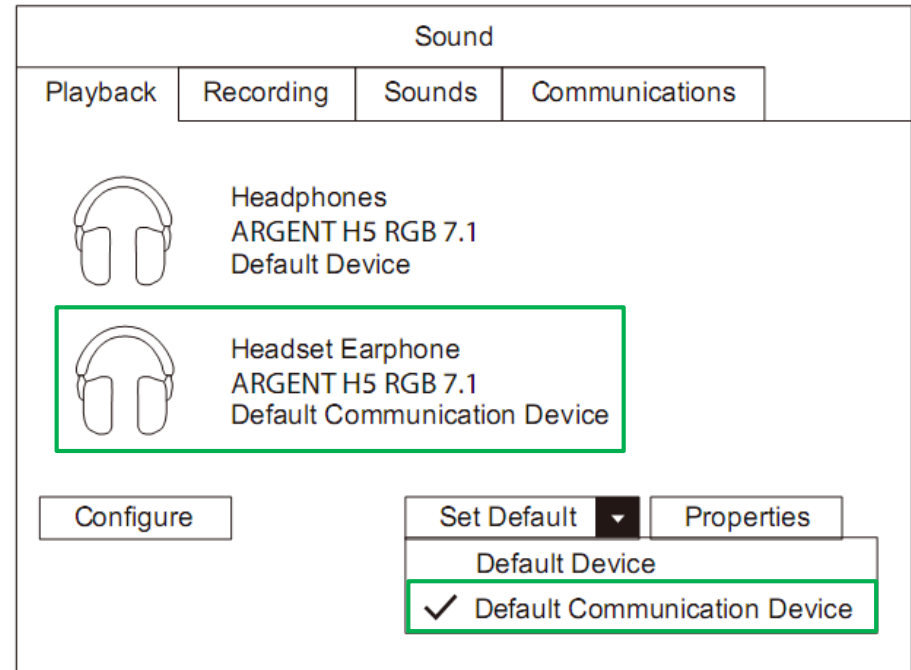

※ The Headphone (ARGENT H5 RGB 7.1) does not support system volume adjustments use the control box to adjust only.



Recording Device Settings Step 1 :

Right click speaker icon -> Select Open Sound settings -> Select Sound control panel.

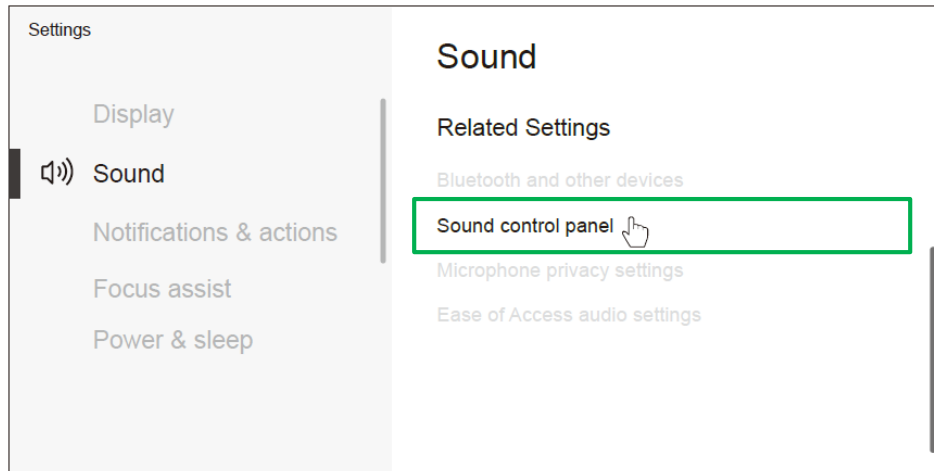
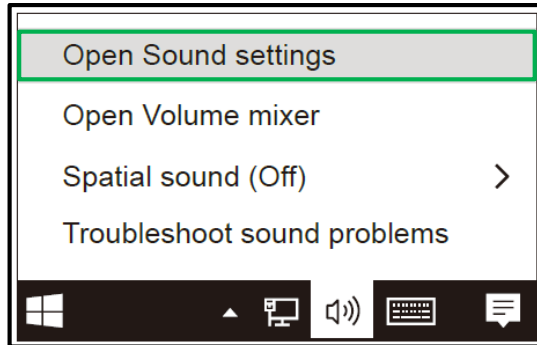

Recording Device Settings Step 2 :

Set Default Device to "Headset Microphone".

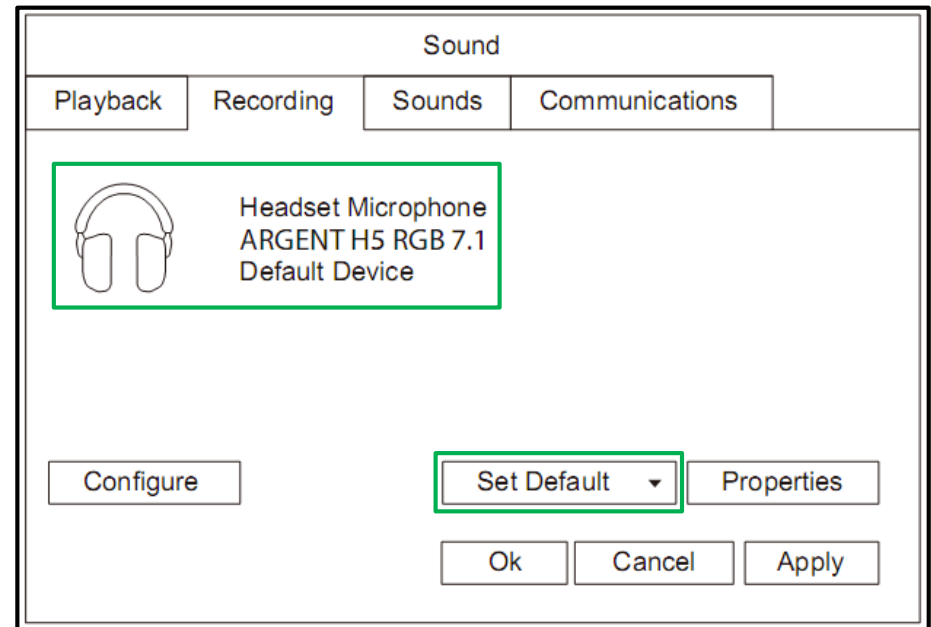



Setting Up With Mobile Devices :

To use the headset with a mobile device (or other device) with a headset jack (4 pole CTIA), connect the 3.5mm plug directly into the headset jack on your device.

Setting Up With Nintendo Switch :

To use the headset with Nintendo Switch, connect the 3.5mm plug on the headset directly to the 3.5mm jack on the Nintendo Switch.

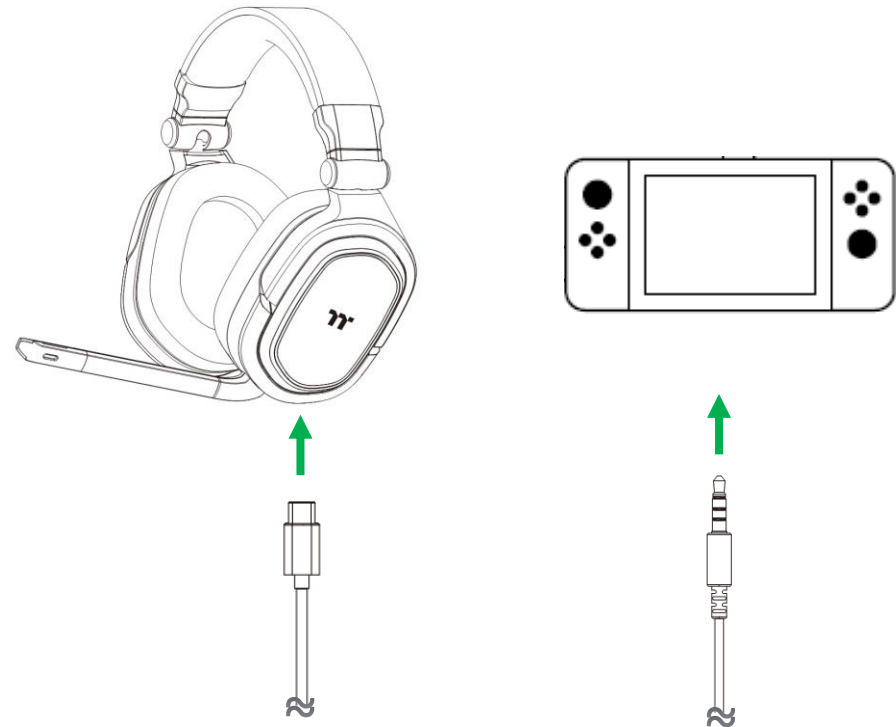
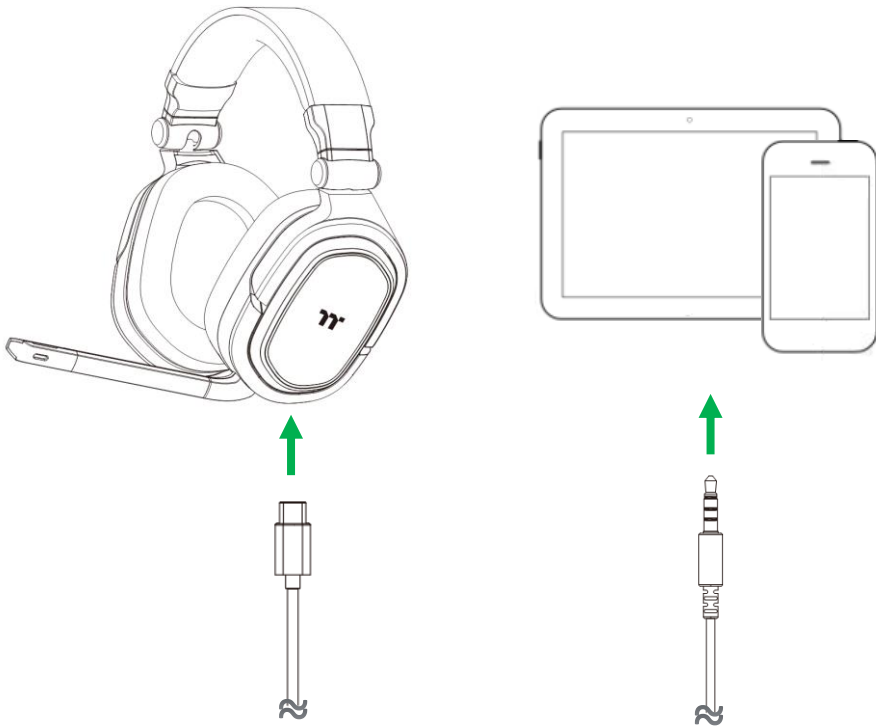



Setting Up With PlayStation Audio :

To use the headset with PlayStation, connect the 3.5mm plug on the headset directly to the PS game controller and follow these steps :

Settings -> Devices -> Audio Devices -> Choose "Output to Headphones" and select "All Audio".

Setting Up With Xbox Audio :

To use the headset with Xbox, connect the 3.5mm plug on the headset directly to the 3.5mm jack on the Xbox controller. ***If your Xbox controller does not have a 3.5mm jack, you will need the Xbox Stereo Headset adapter (sold separately) that plugs into the Xbox controller (pictured below).**

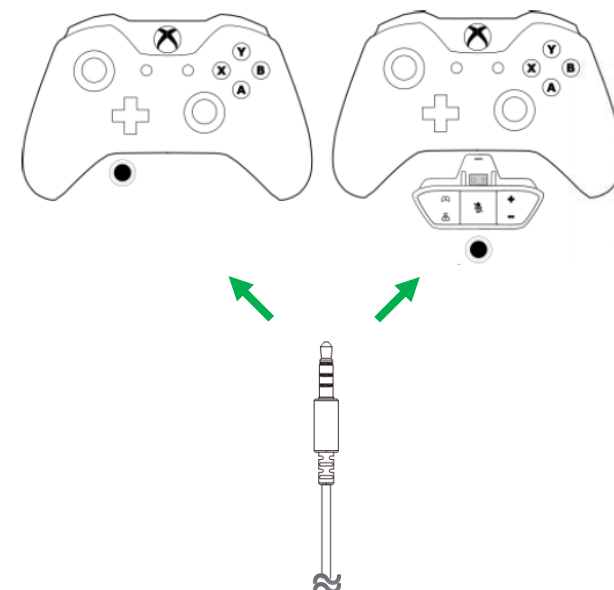
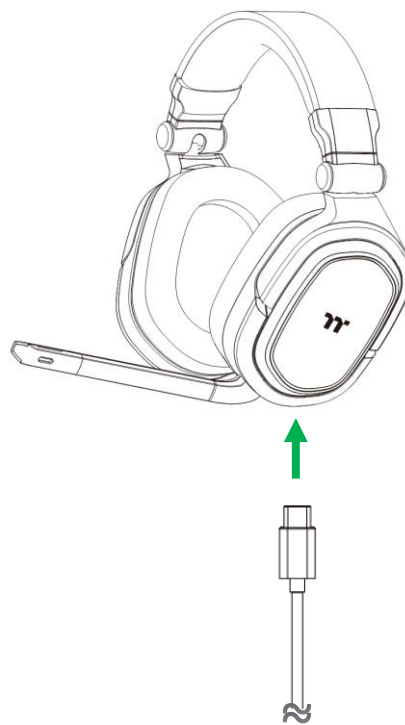
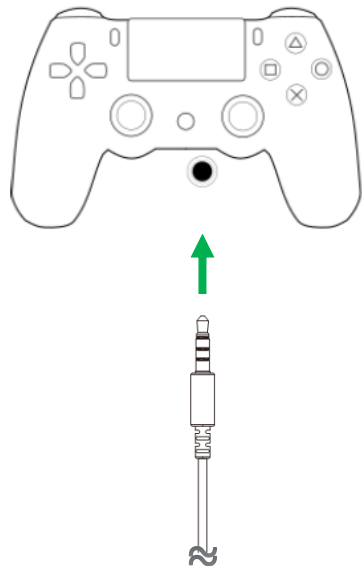
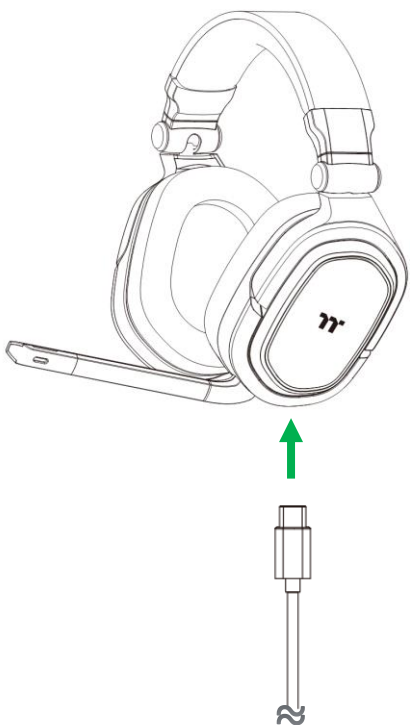

Step 1 :

Left click speaker icon and select "Headphones (ARGENT H5 RGB 7.1)".

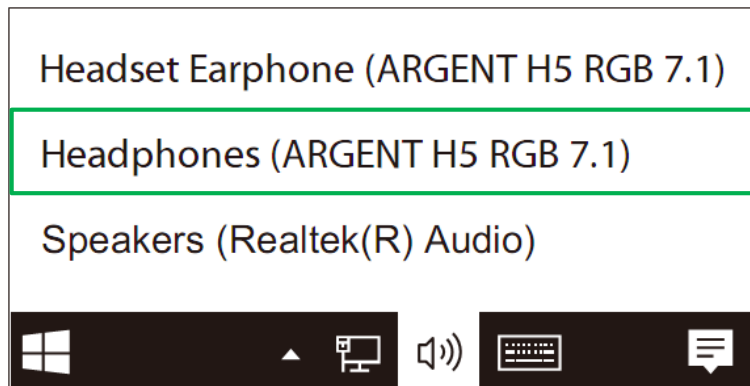

Step 2 :

Press game/chat balance button and rotate the wheel to increase the in-game volume and decrease the voice chat volume or vice versa.

Press the TT Logo button to mute or unmute the game/chat balance volume.

When muted the TT logo will light up to indicate the headset is set to mute.





Step 1 :

Left click speaker icon and select "Headphones (ARGENT H5 RGB 7.1)".

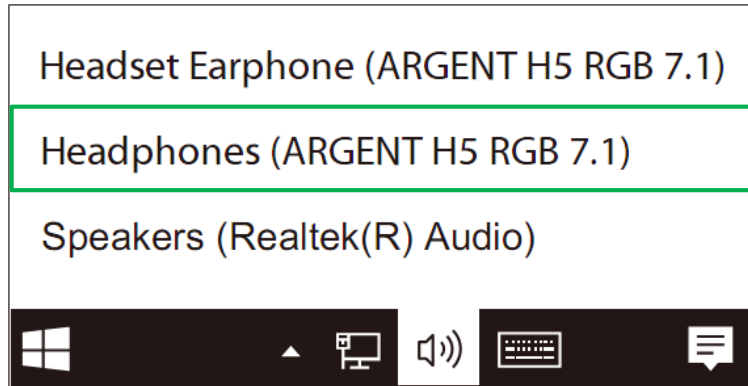

Step 2 :

Press DTS button to enable or disable the 7.1 Surround Sound. Rotate wheel to increase / decrease the 7.1 Surround Sound volume.

Press the TT Logo button to mute or unmute the 7.1 Surround Sound volume. When 7.1 Surround Sound is muted the TT logo will light up to indicate it has been set to mute.

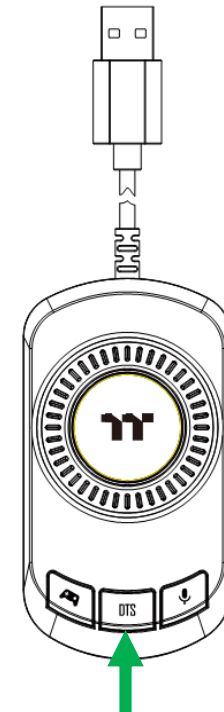



Step 1 :

Set Input Device to "Headset Microphone (ARGENT H5 RGB 7.1)".

Step 2 :

Set Output Device to "Headphones (ARGENT H5 RGB 7.1)".

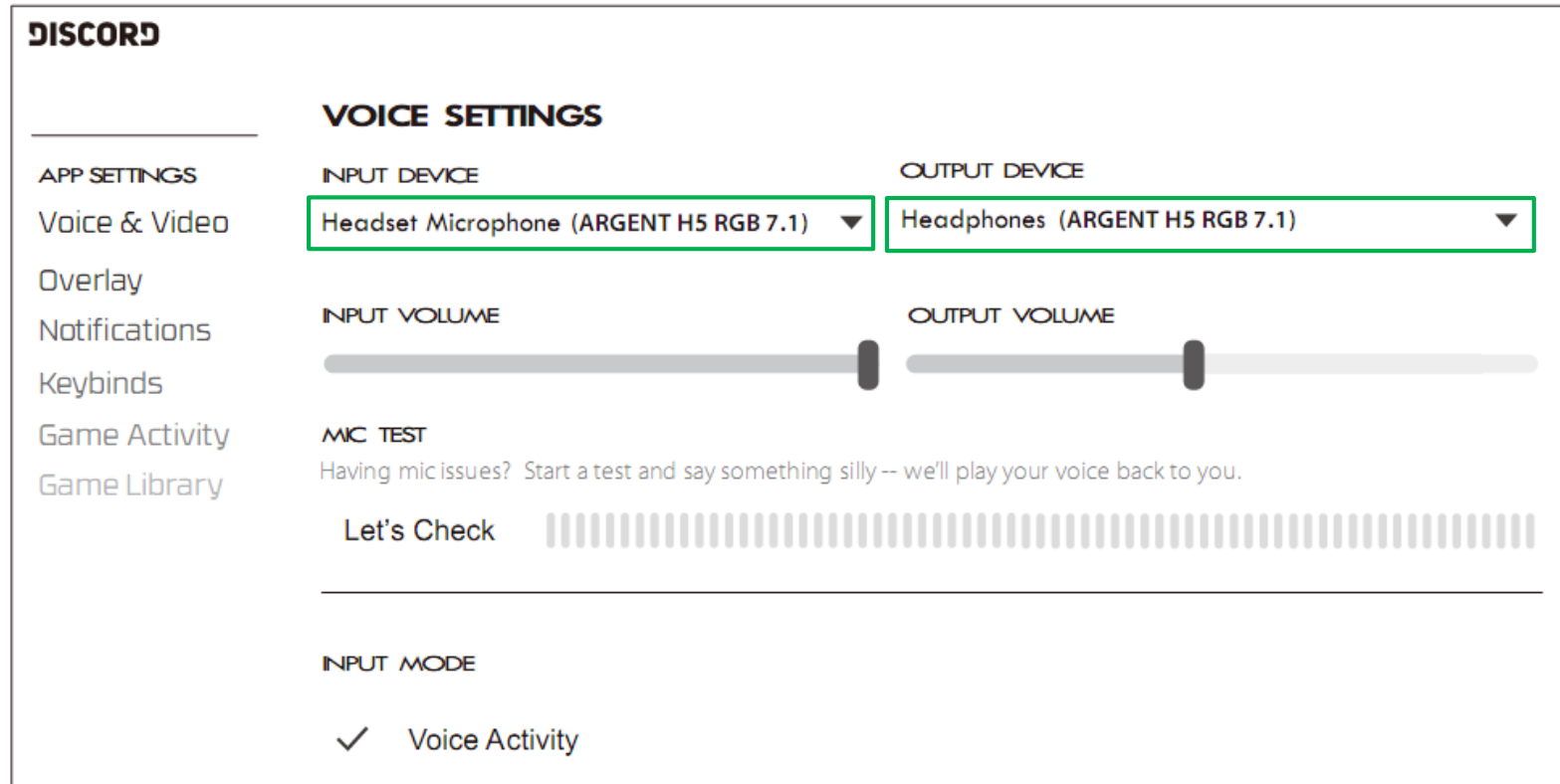

| Chapter 2 : TT iTAKE INSTALLATION

Step 1:

Launch the setup executable file (.EXE) file and click Next.

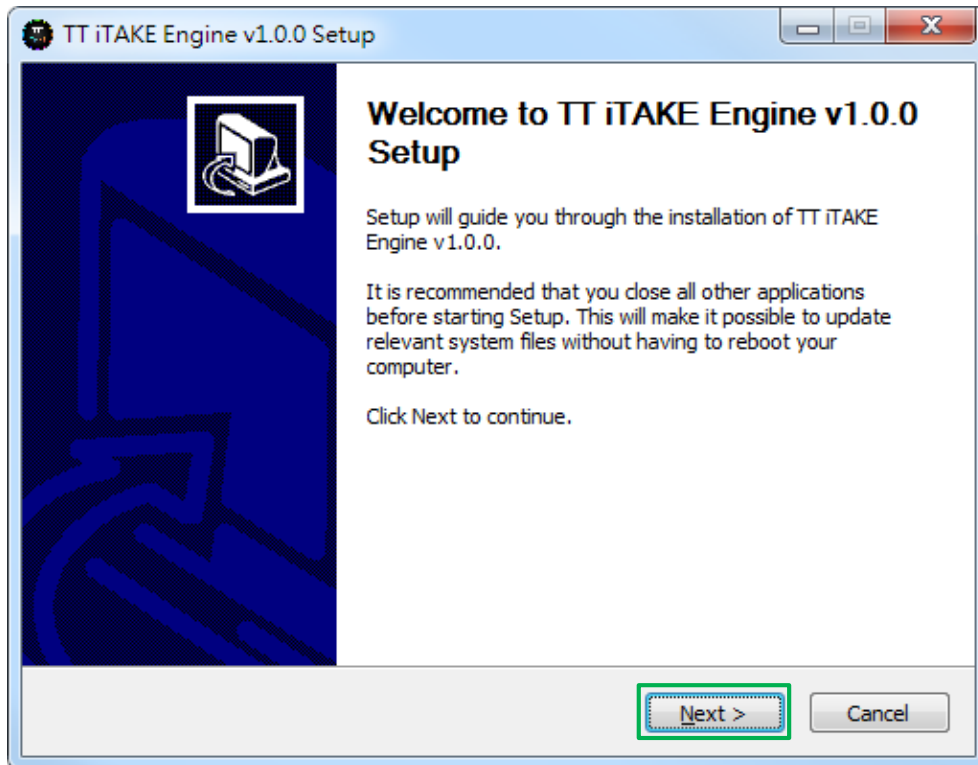

Step 2:

Click Install to begin the setup process.

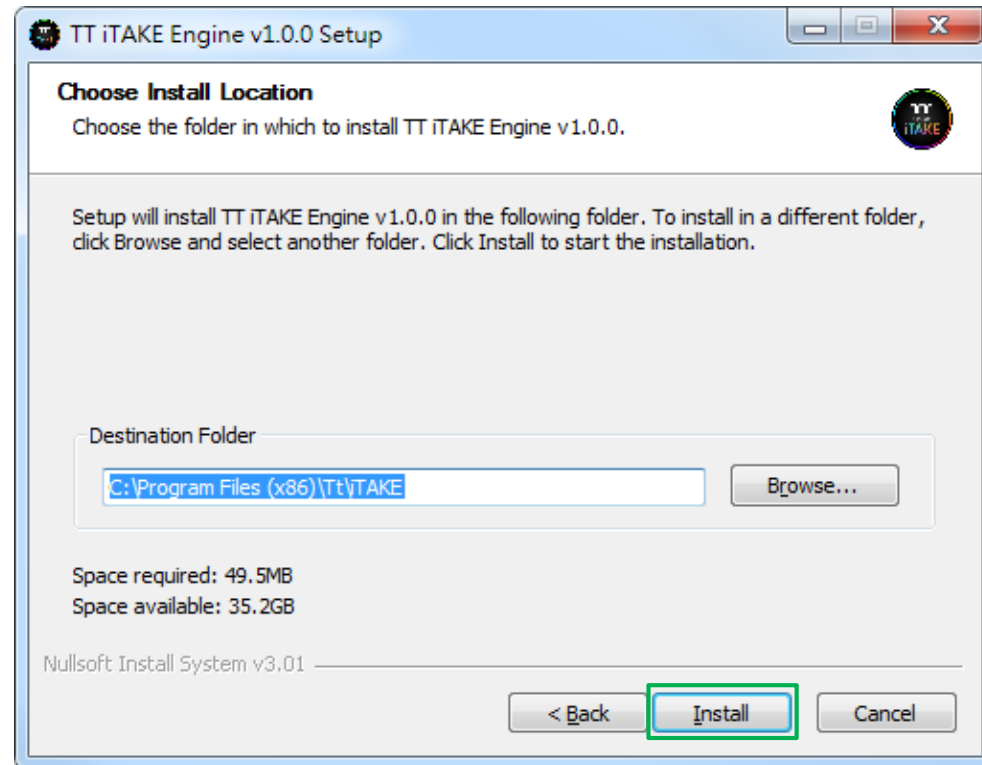

Step 3:

Once setup is complete, you will also need to install the Microsoft Visual C++ 2015 Redistributable Package.

✘ Without installing the Redistributable Package, the software will fail to launch.

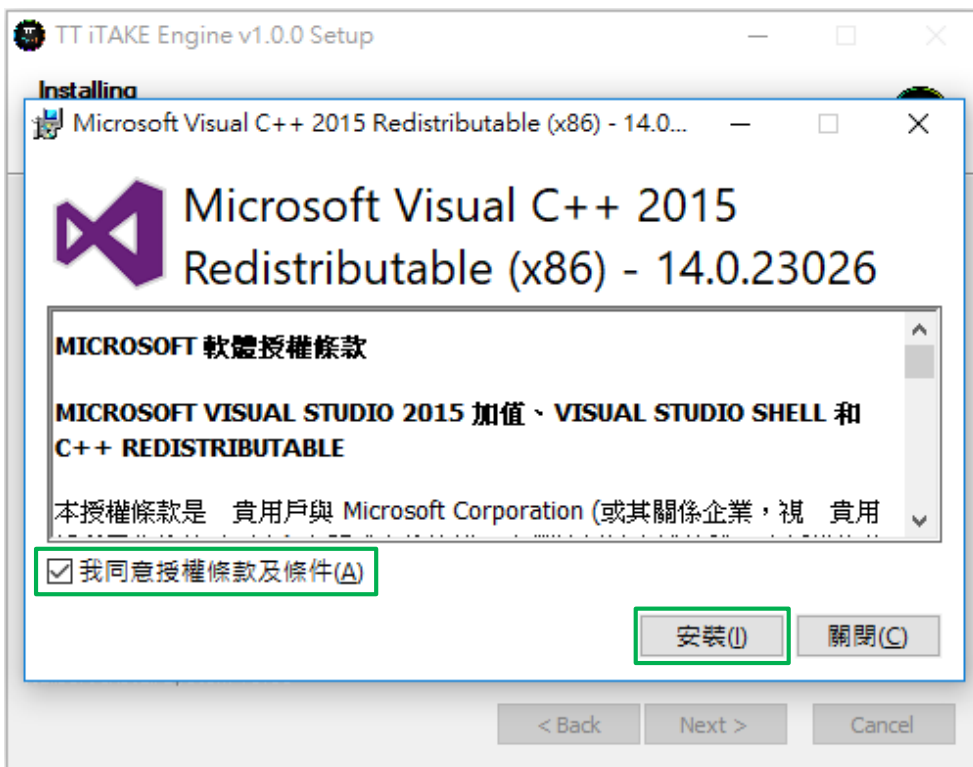

Step 4:

Click Finish to complete the installation.

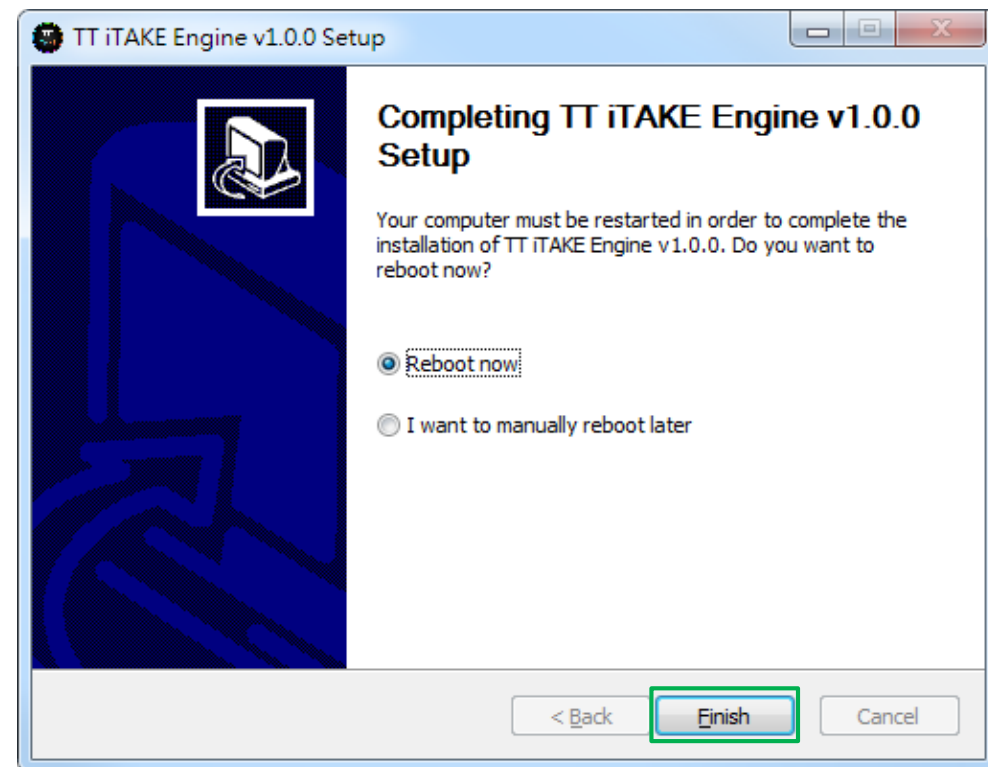

| Chapter 3 : FUNCTIONS AVAILABLE ON THE LIGHTING EFFECTS PAGE

Lighting Effects

Headset light of 8 lighting effects are supported: Static, Pulse, Blink, Spiral Rainbow, RGB Spectrum, Raindrops, Snake and System Temperature.

Lighting Effect Configurations

Can be used to adjust the color, direction, speed, and brightness level of the lighting effect; can also be used to switch to random colors.

Apply / Restore Lighting Effect Settings

Apply: Apply the new lighting effect settings on the headset.
Restore Lighting Effect Settings: All lighting effect settings saved under the current profile will be restored to factory default values.

Color Pattern Settings

Add Pattern: Add a new pattern with red to black gradient.
Delete Pattern: Delete the currently selected color pattern.
Insert Color Point: Add a red color point to the color pattern.
Delete Color Point: Delete the selected color point from the color pattern.

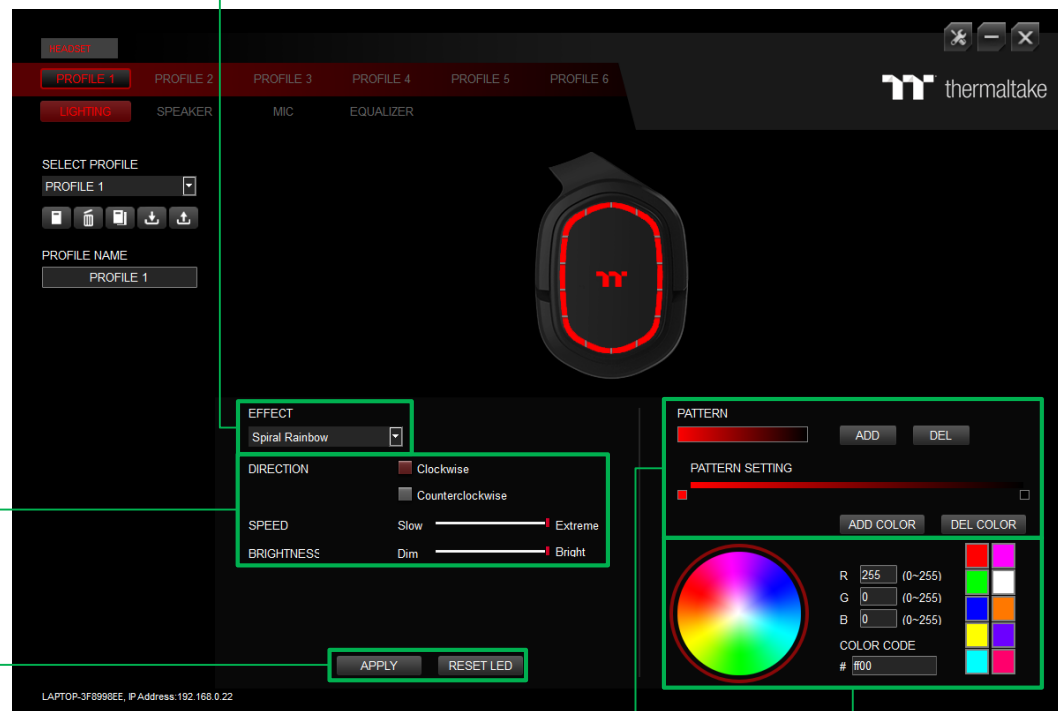

Color Wheel Settings

You can select a color from the color wheel directly or enter RGB color values to adjust the color of the lighting effect.

| Chapter 4 : LIGHTING EFFECTS OVERVIEW

Step 1:

Select "Static" in the Lighting Effect drop-down list.

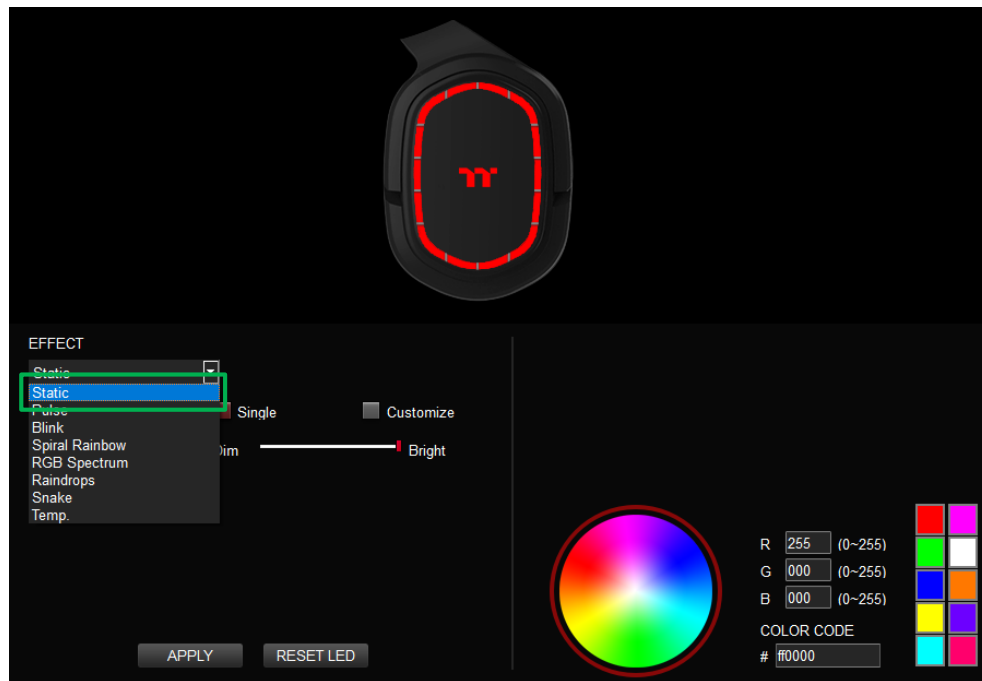

Step 2:

Click on a color inside the color wheel or enter the RGB color values to change the color.

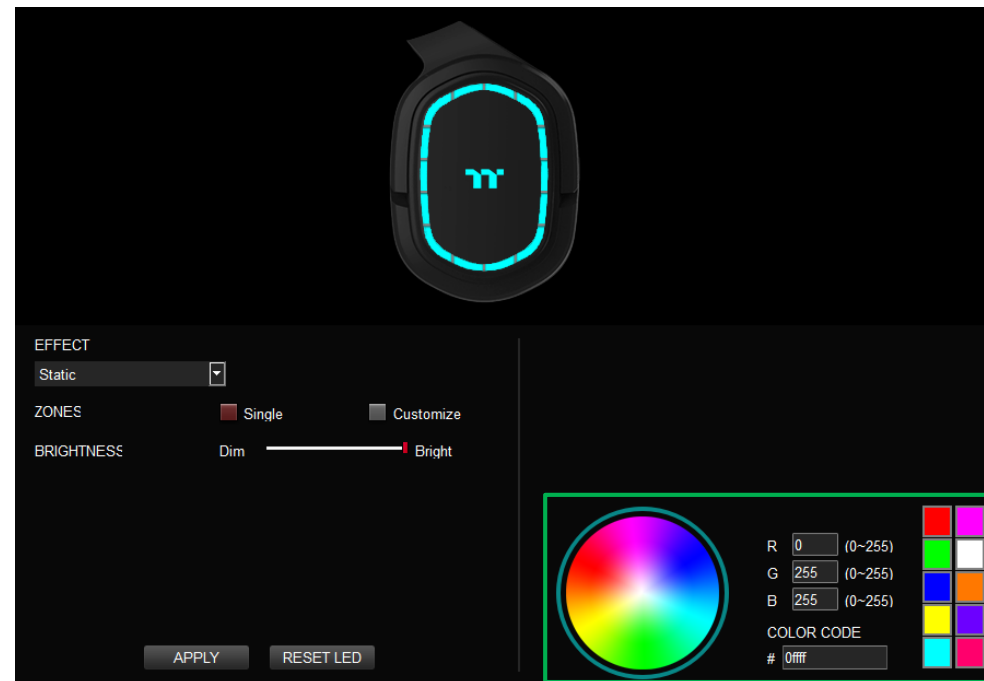



Step 3:

Adjust the brightness level of the headset's backlight.

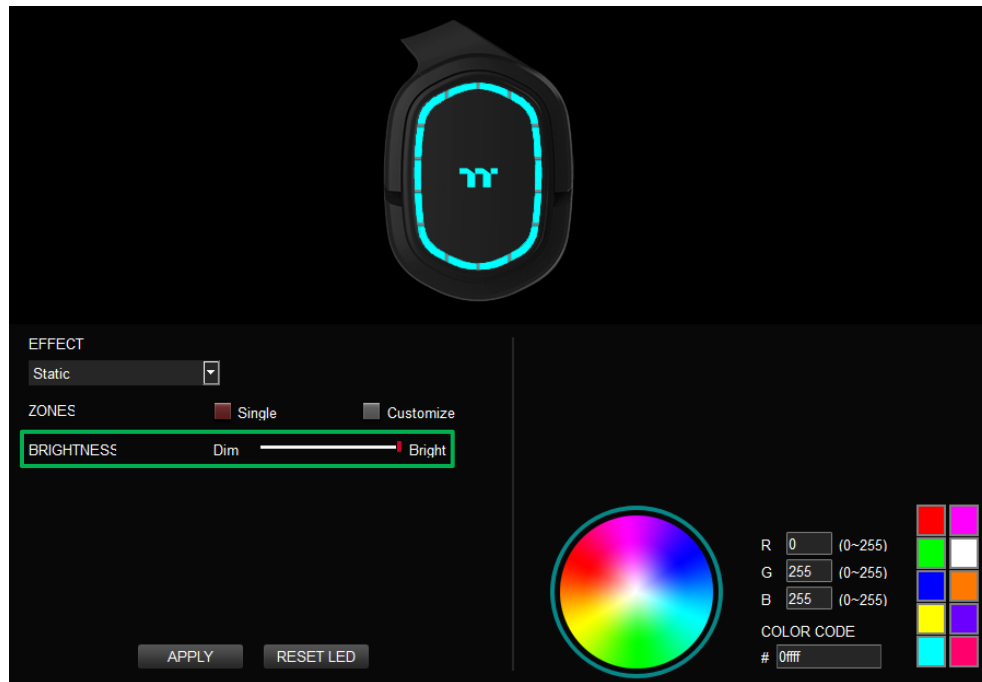

Step 4:

Click Apply to save the new settings.

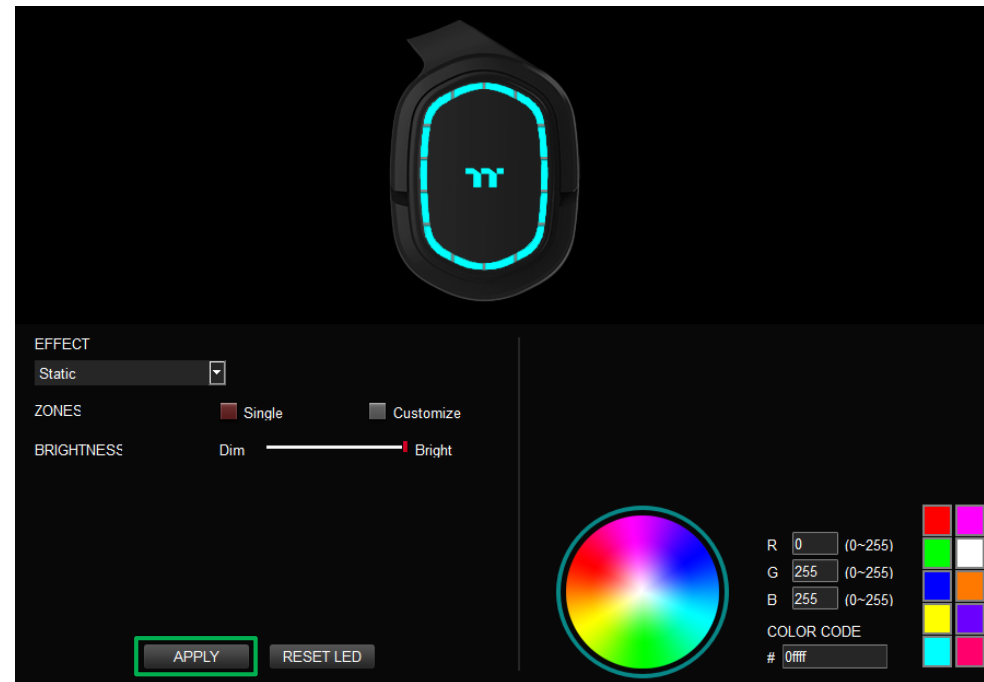



Step 1:

Switch the zones to "Customized."

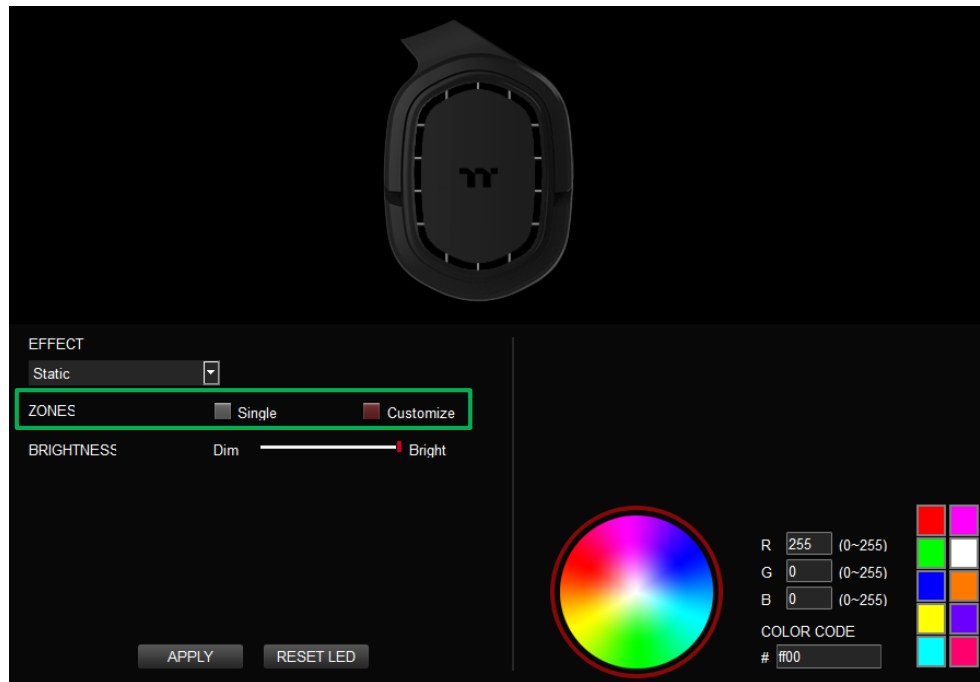

Step 2:

Click on a color inside the color wheel or enter the RGB color values to change the color.

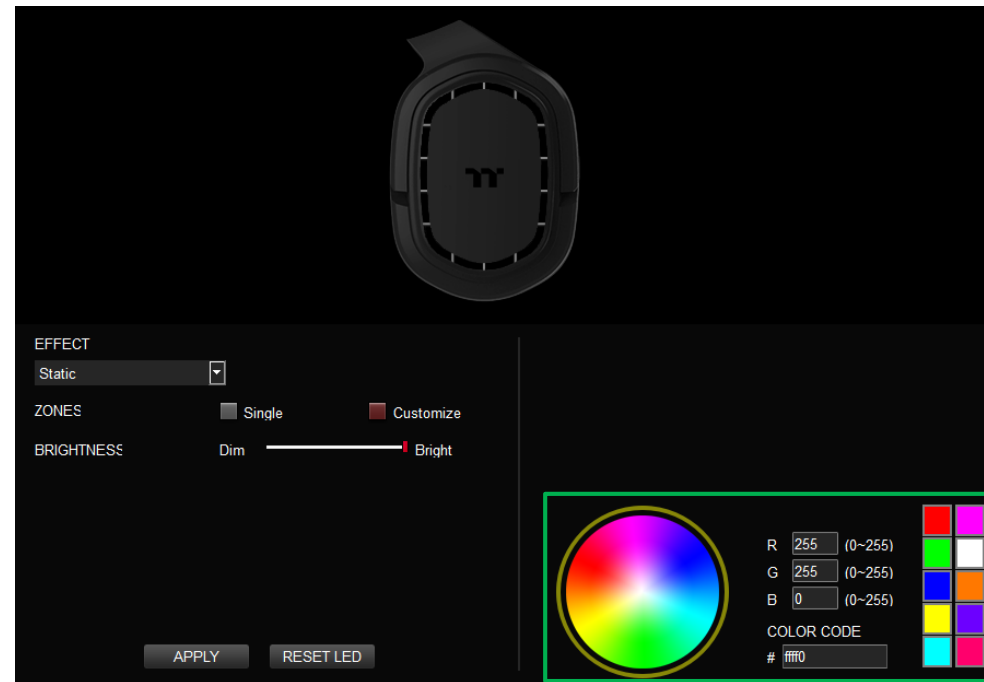



Step 3:

Click on the headset image directly with the left mouse button to change the color.

✘ Right click to cancel the color.

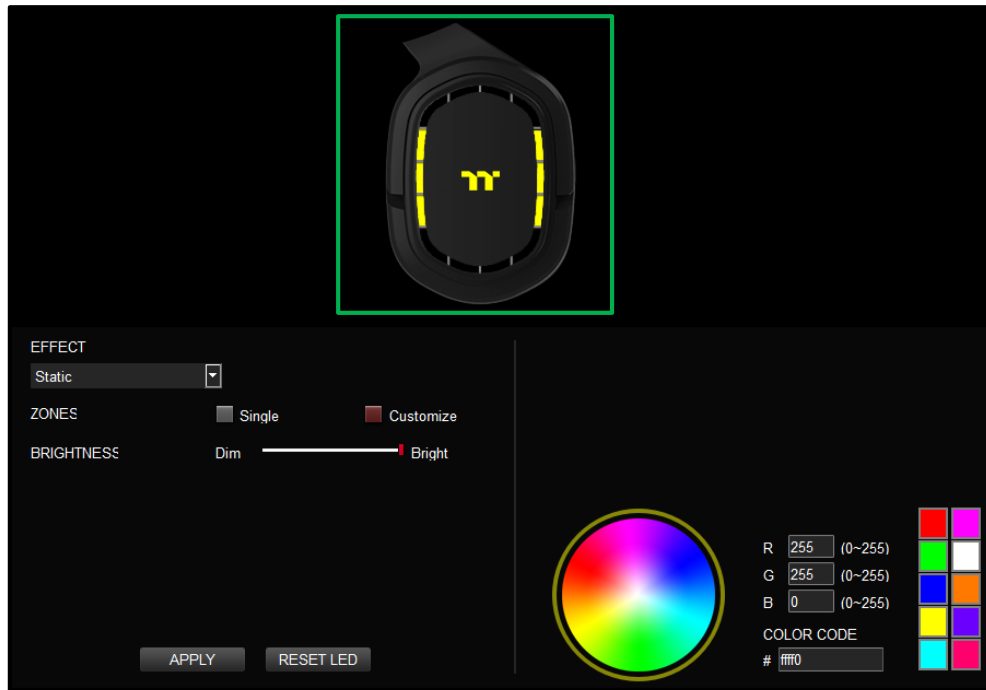

Step 4:

Click Apply to save the new settings.

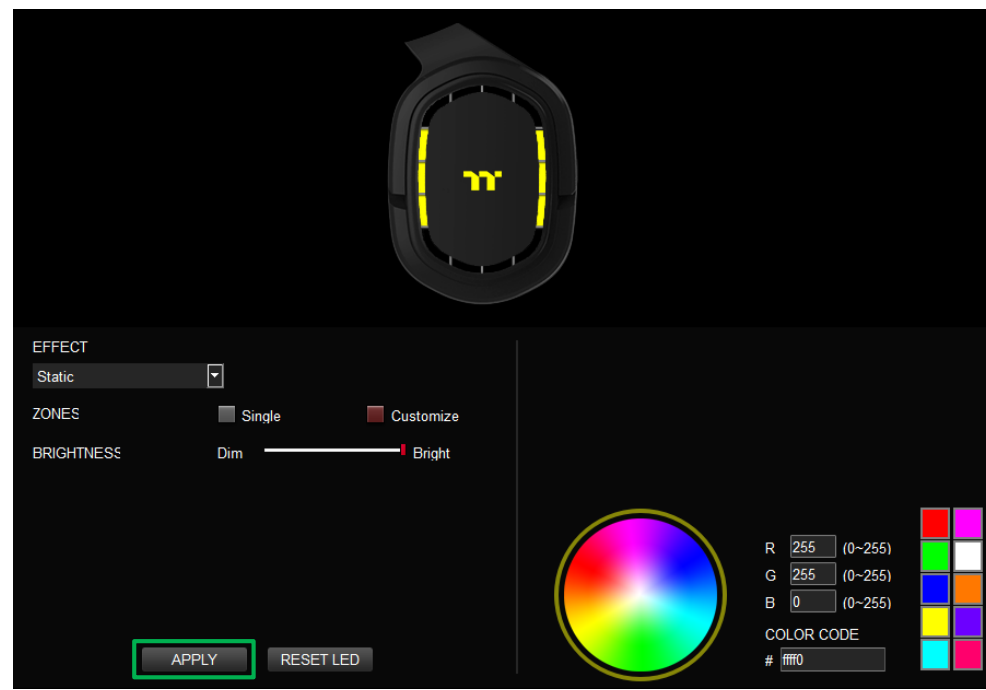

Step 1:

Select "Pulse" in the Lighting Effect drop-down list.

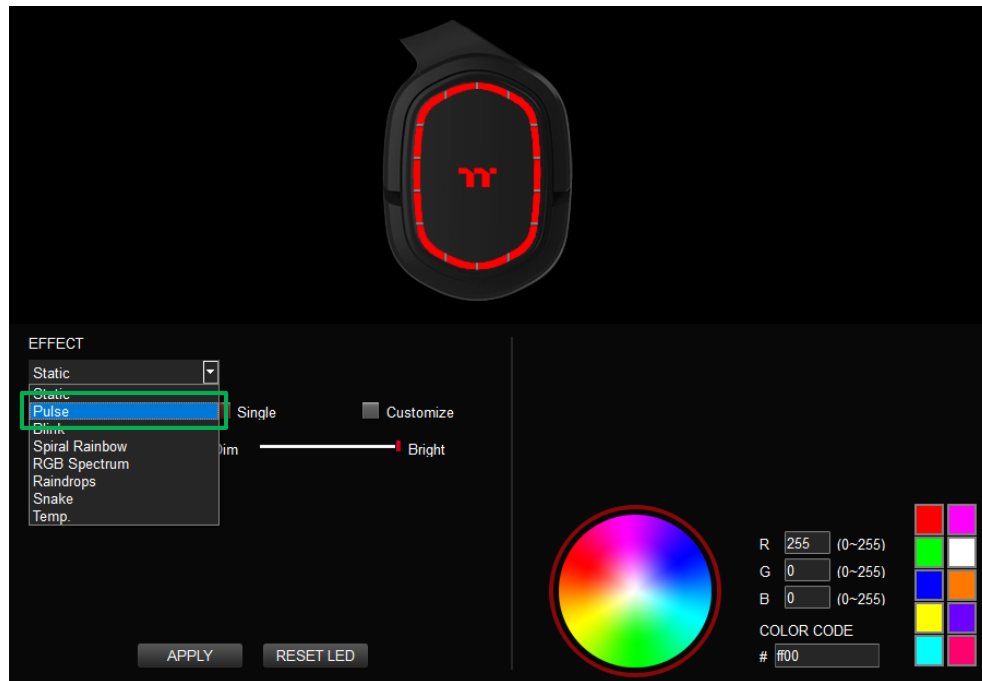

Step 2:

Click on a color inside the color wheel or enter the RGB color values to change the color.

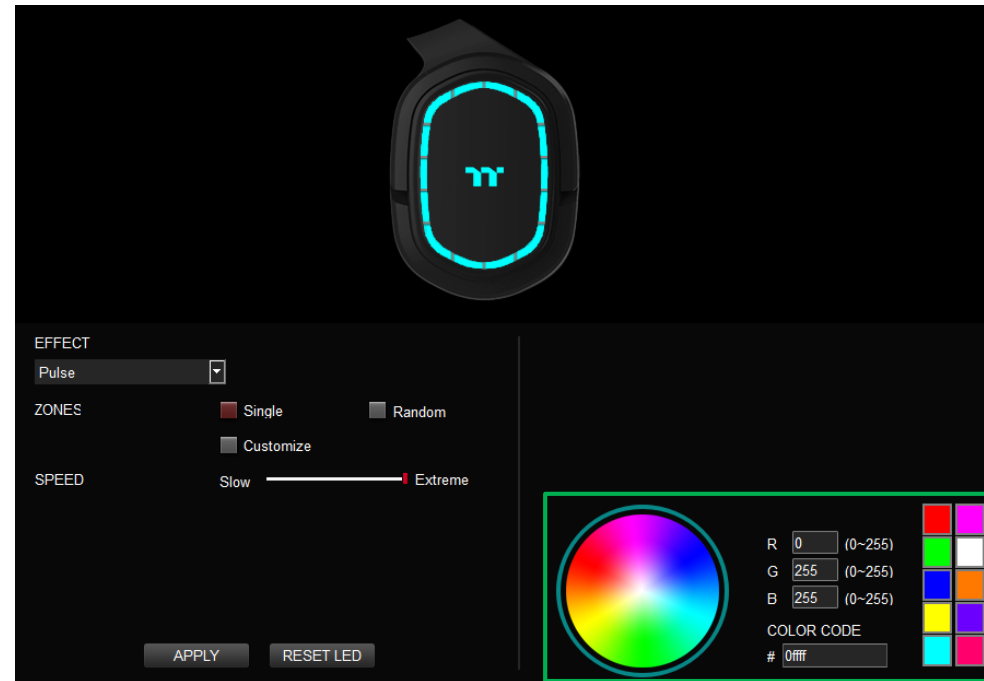

Step 3:
Adjust the backlight speed.

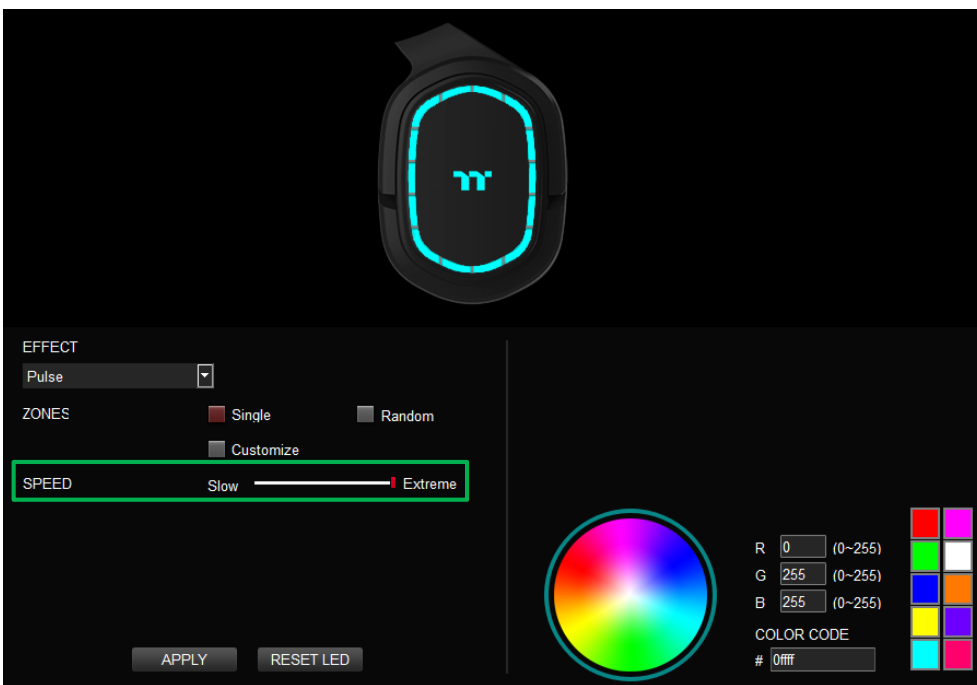

Step 4:
Click Apply to save the new settings.

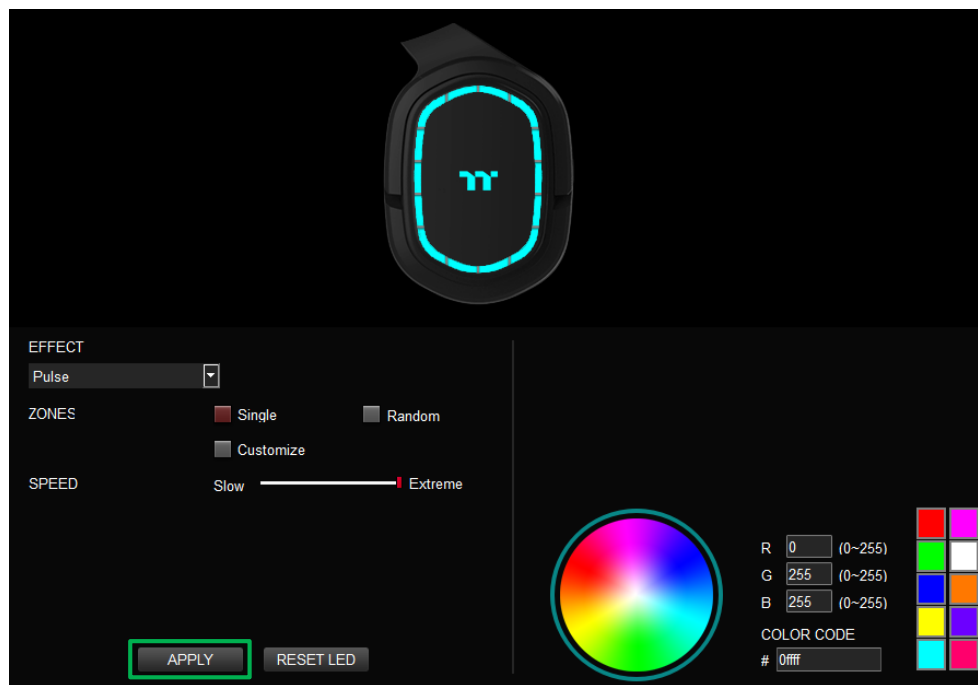



Step 1:

Switch the zones to "Customized."

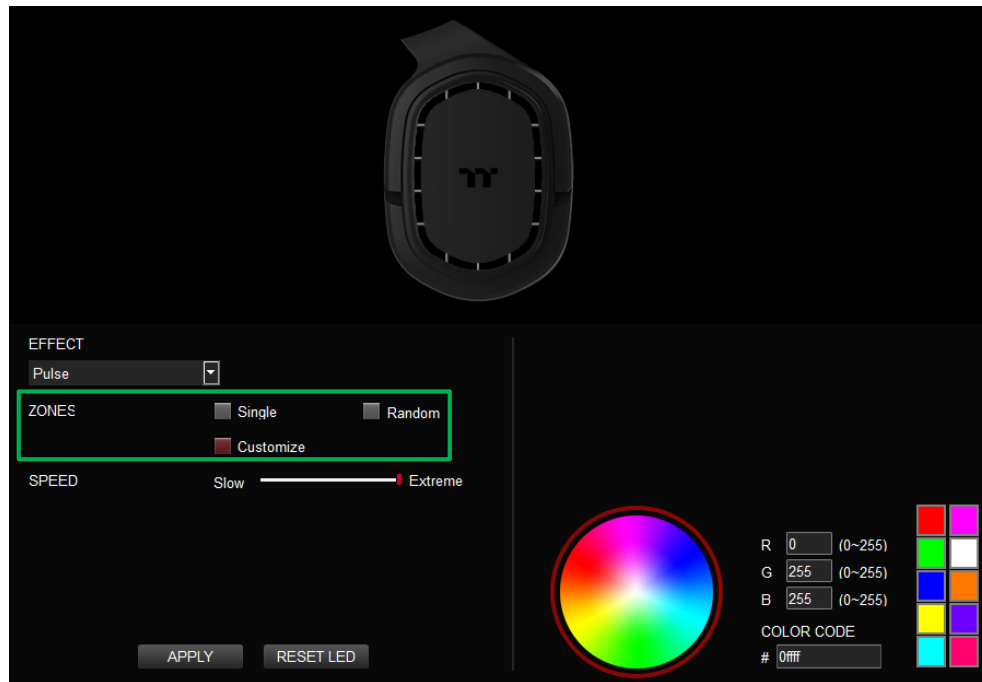

Step 2:

Click on a color inside the color wheel or enter the RGB color values to change the color.

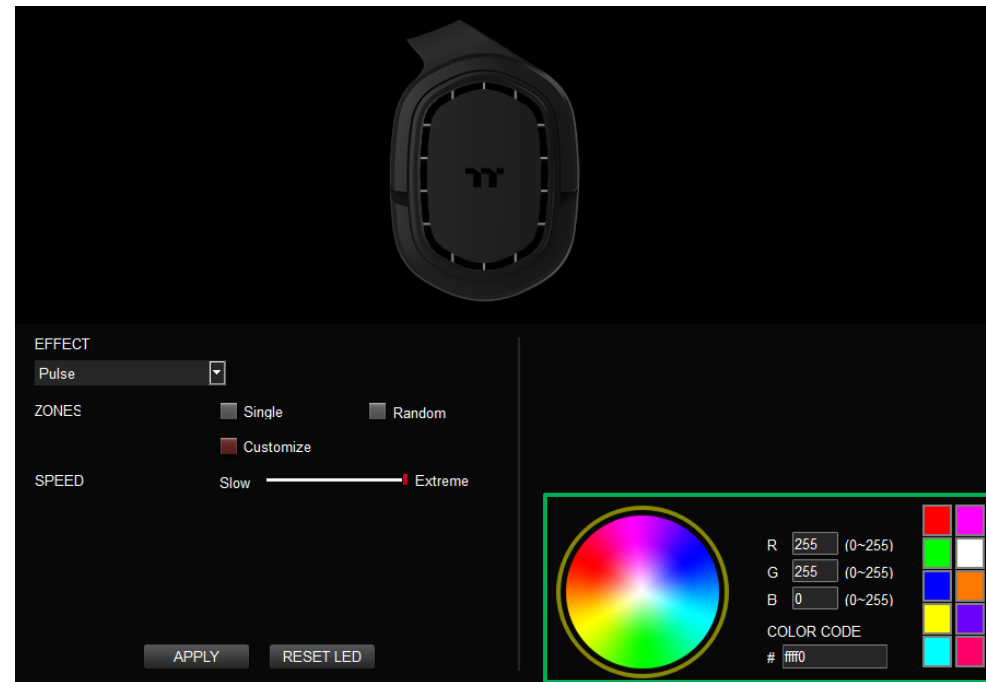



Step 3:

Click on the headset image directly with the left mouse button to change the color.

✘ Right click to cancel the color.

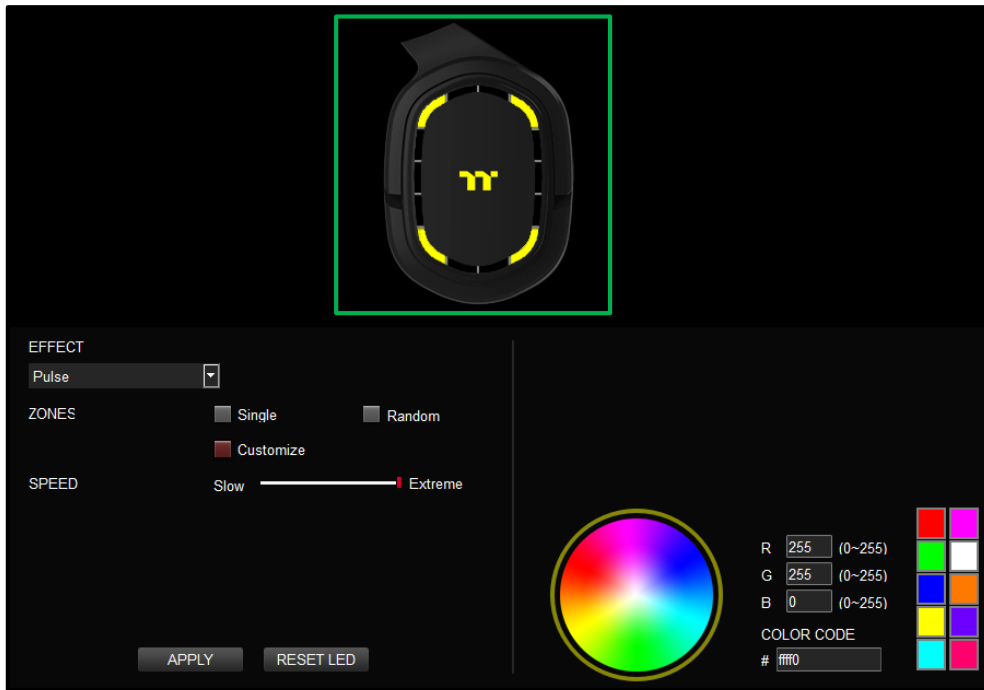

Step 4:

Click Apply to save the new settings.

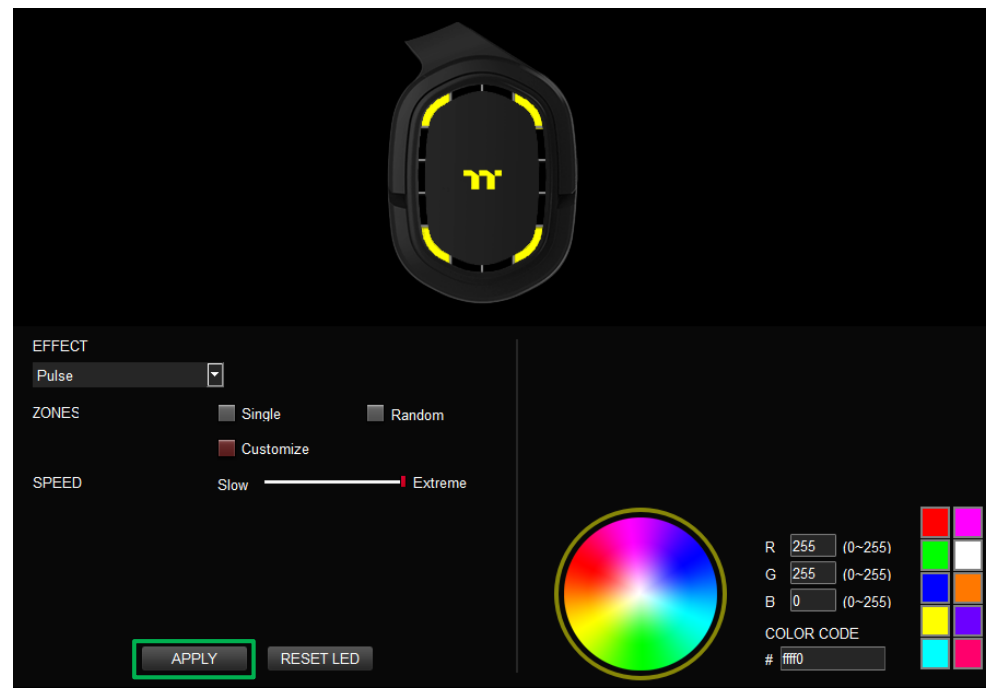

Step 1:

Select "Blink" in the Lighting Effect drop-down list.

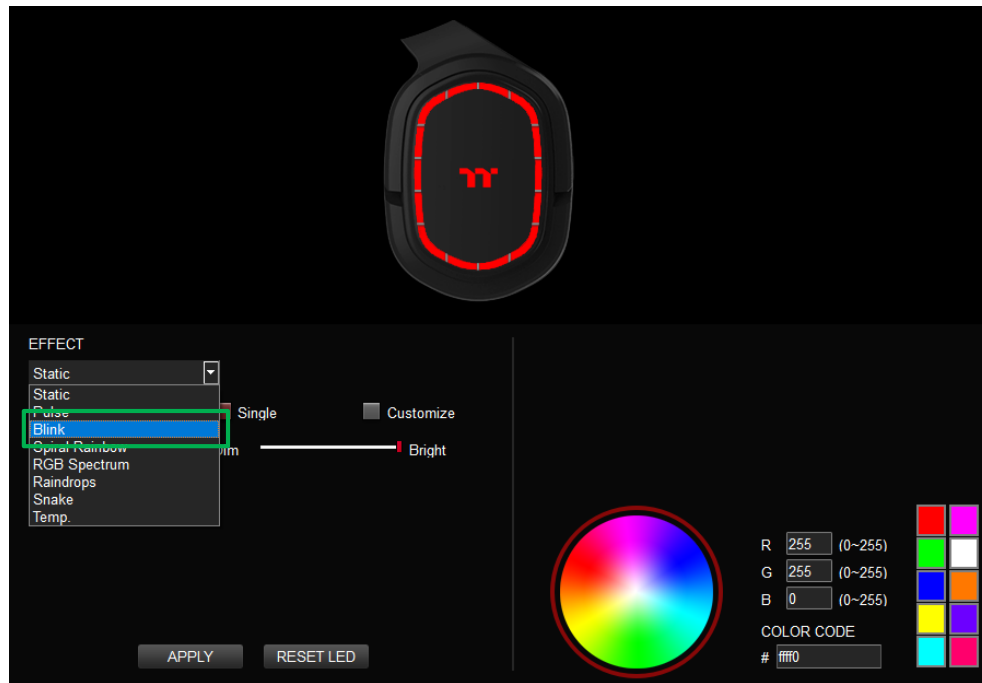

Step 2:

Click on a color inside the color wheel or enter the RGB color values to change the color.

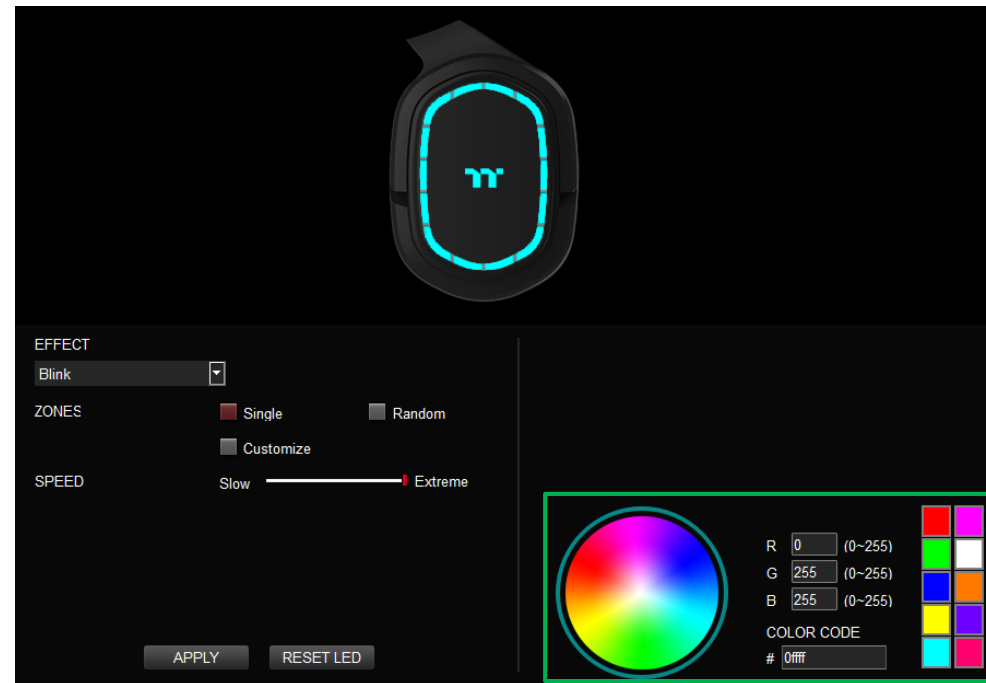



Step 3:

Adjust the backlight speed.

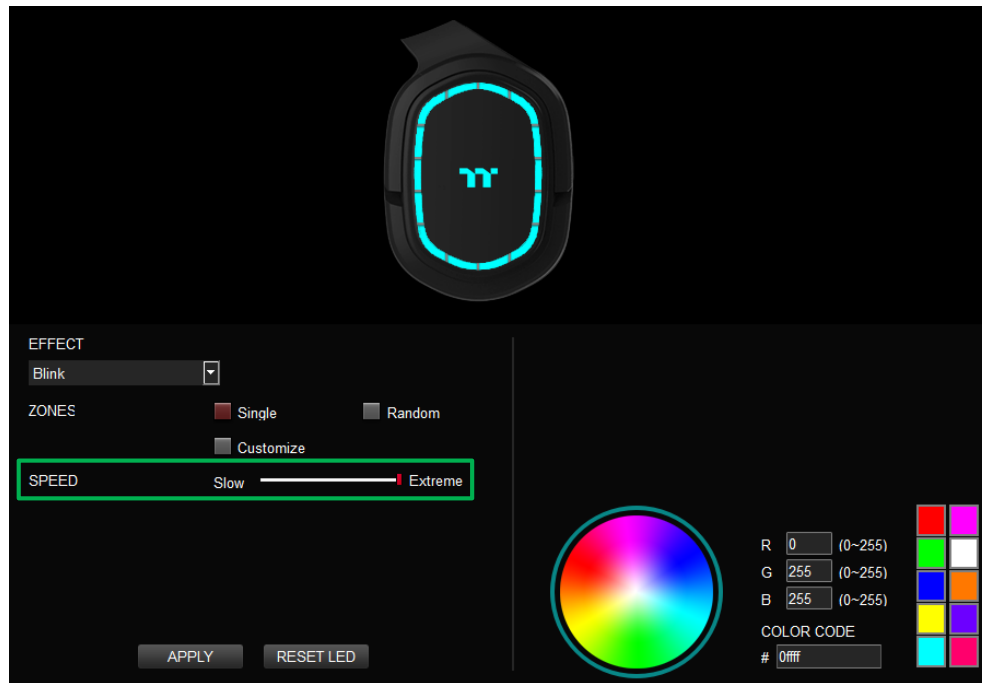

Step 4:

Click Apply to save the new settings.

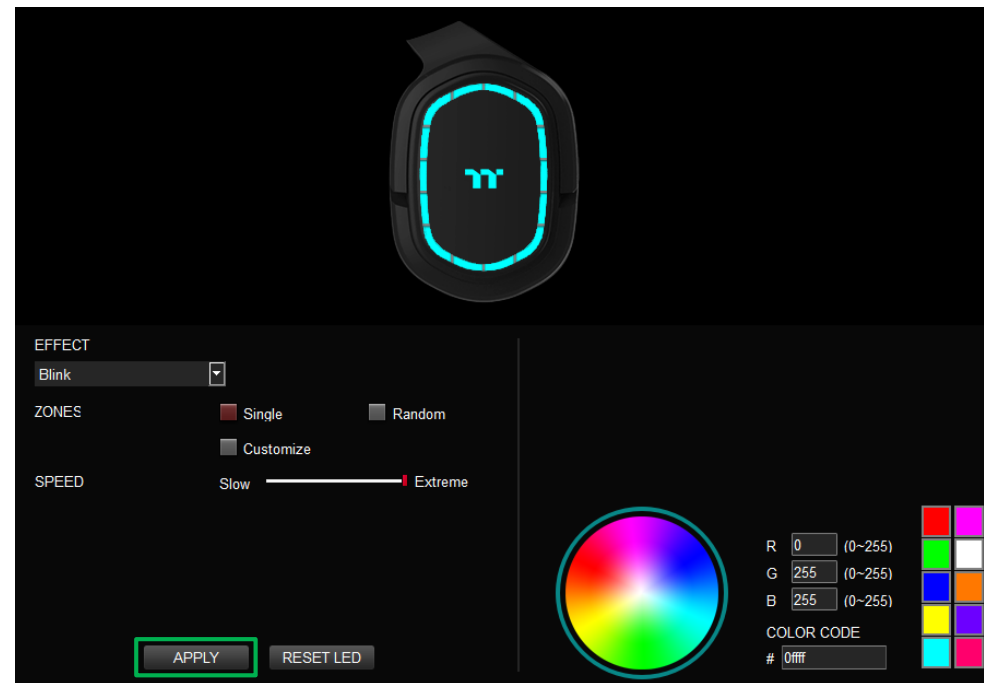



Step 1:

Switch the zones to "Customized."

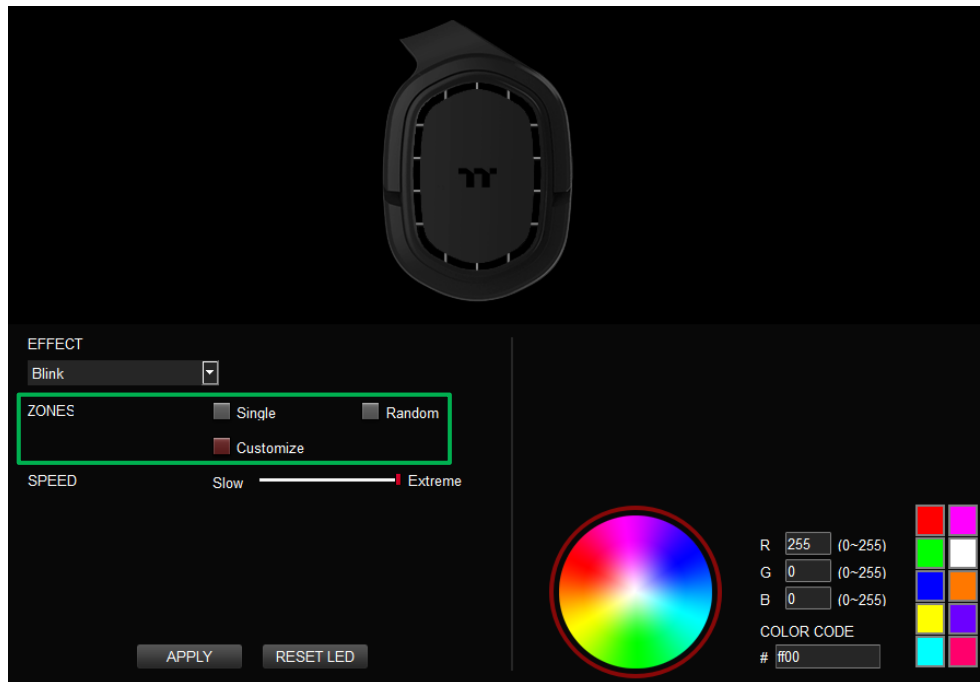

Step 2:

Click on a color inside the color wheel or enter the RGB color values to change the color.

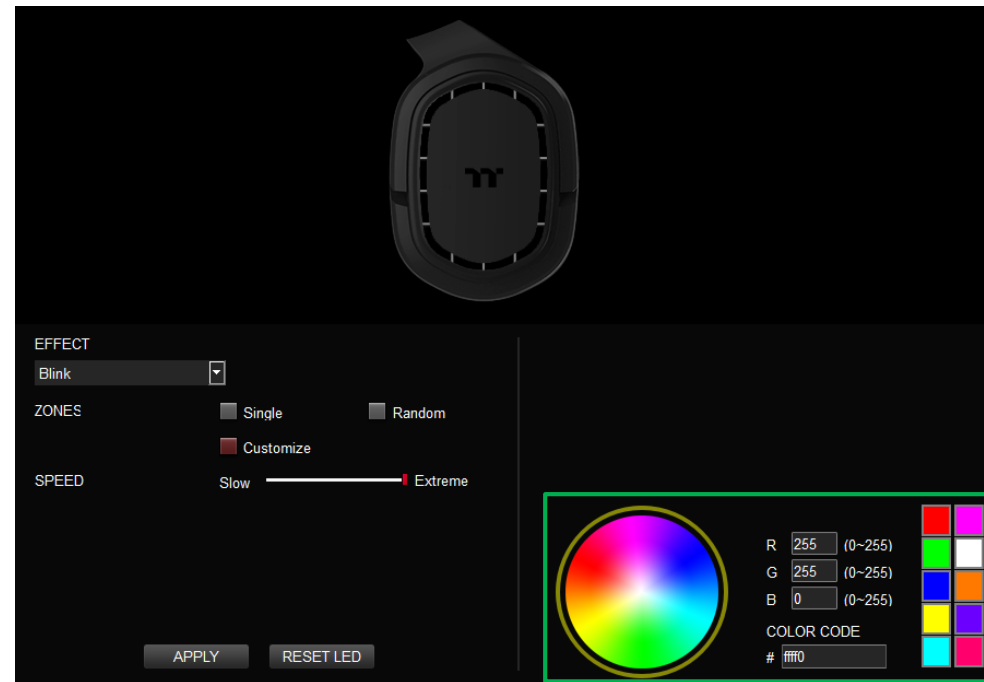



Step 3:

Click on the headset image directly with the left mouse button to change the color.

✘ Right click to cancel the color.

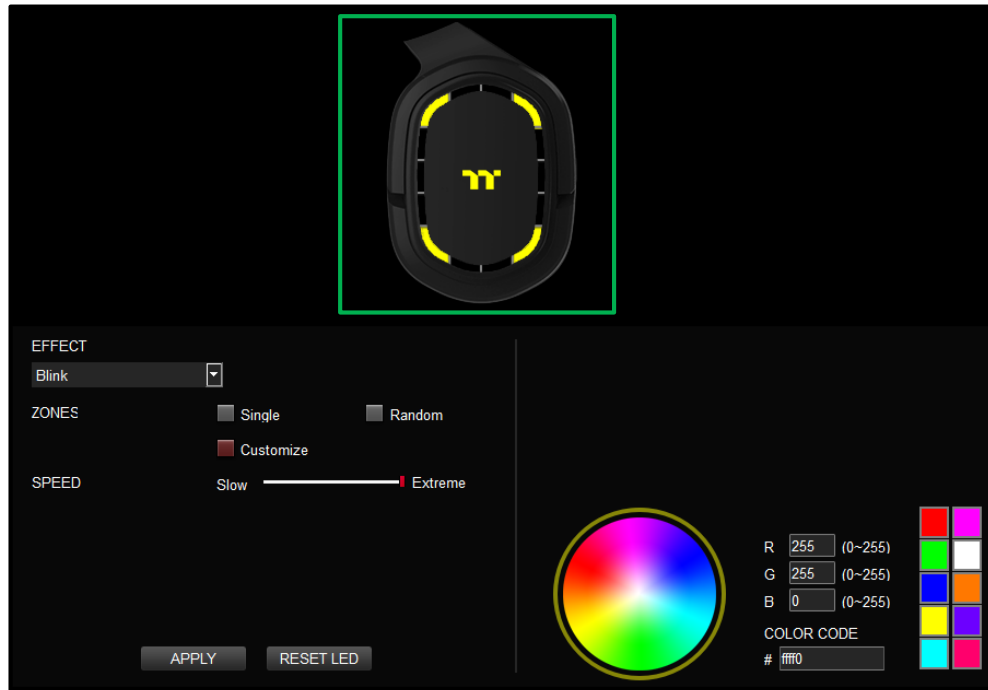

Step 4:

Click Apply to save the new settings.

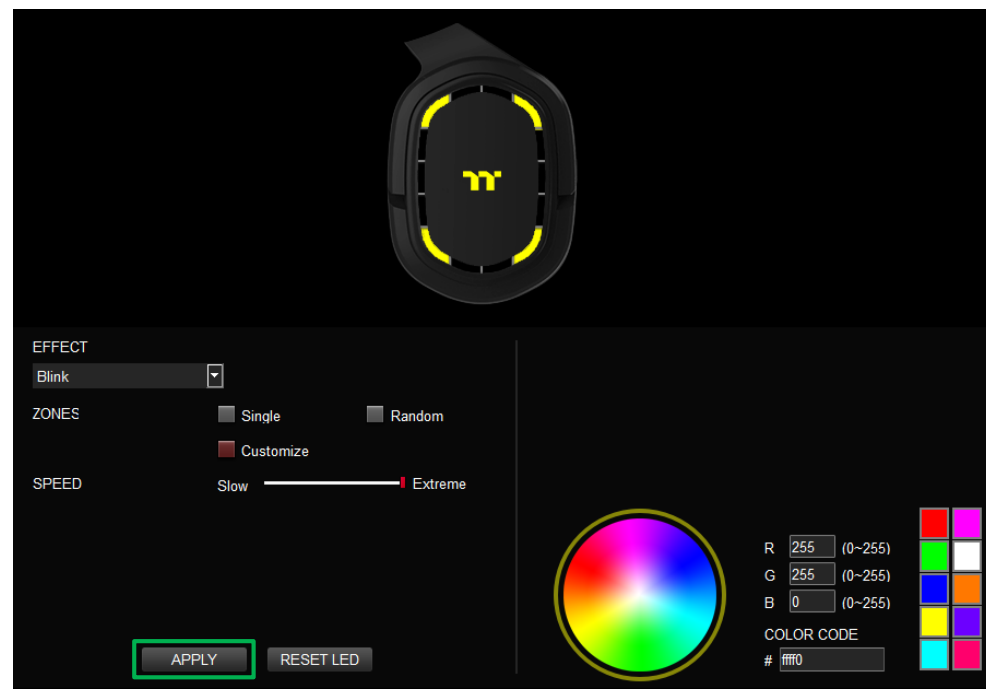



Step 1:

Select "Spiral Rainbow" in the Lighting Effect drop-down list.

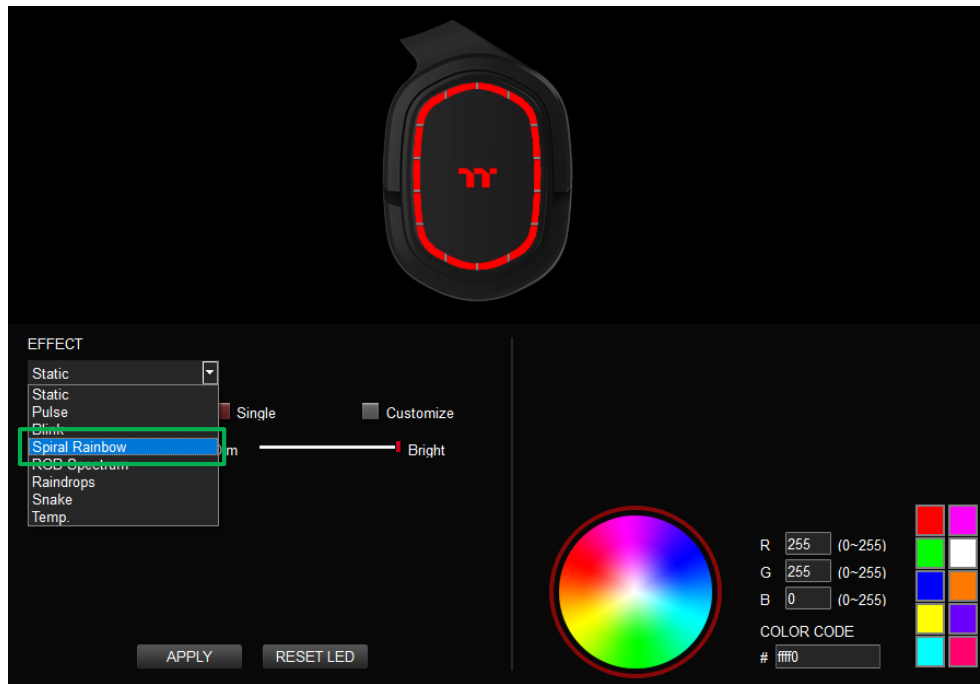

Step 2:

Select a set of color patterns on the upper-right.

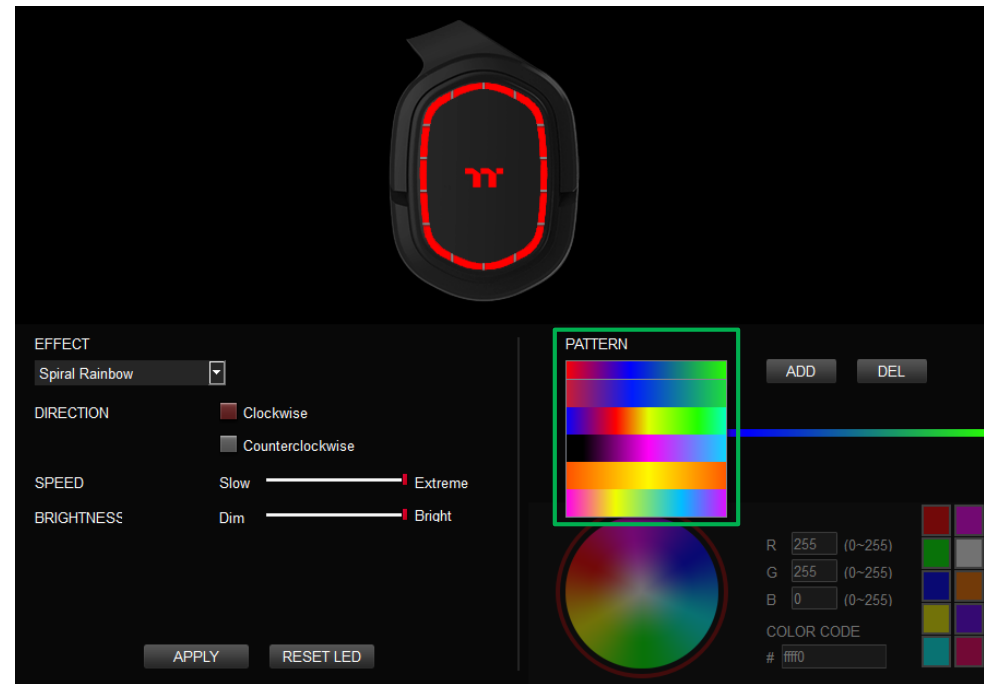



Step 3:

Set the direction, speed, and brightness level of the lighting effect.

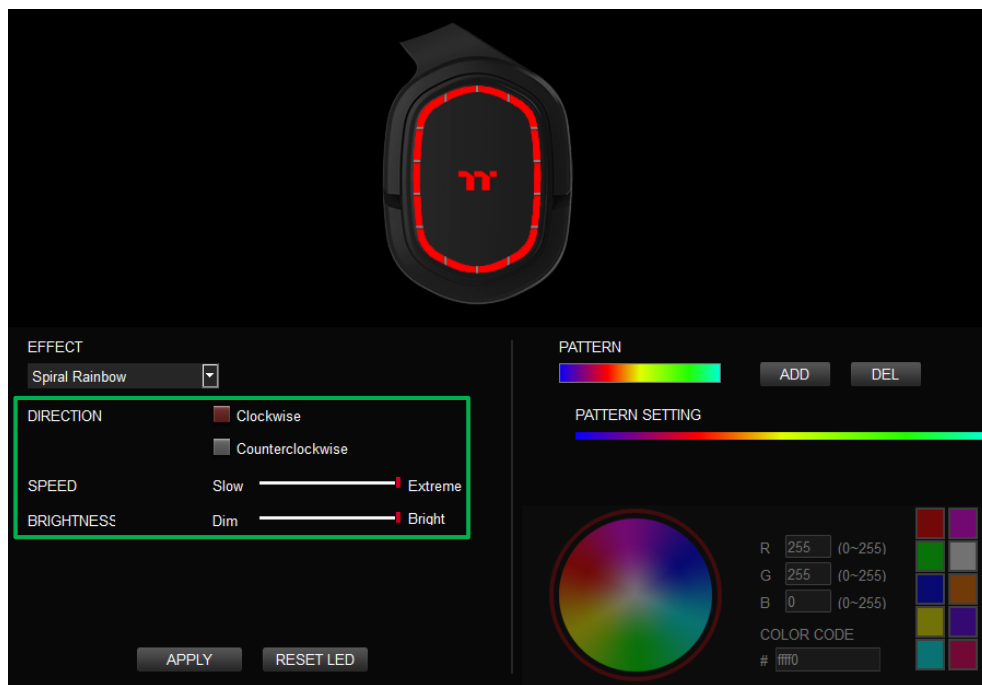

Step 4:

Click Apply to save the new settings.

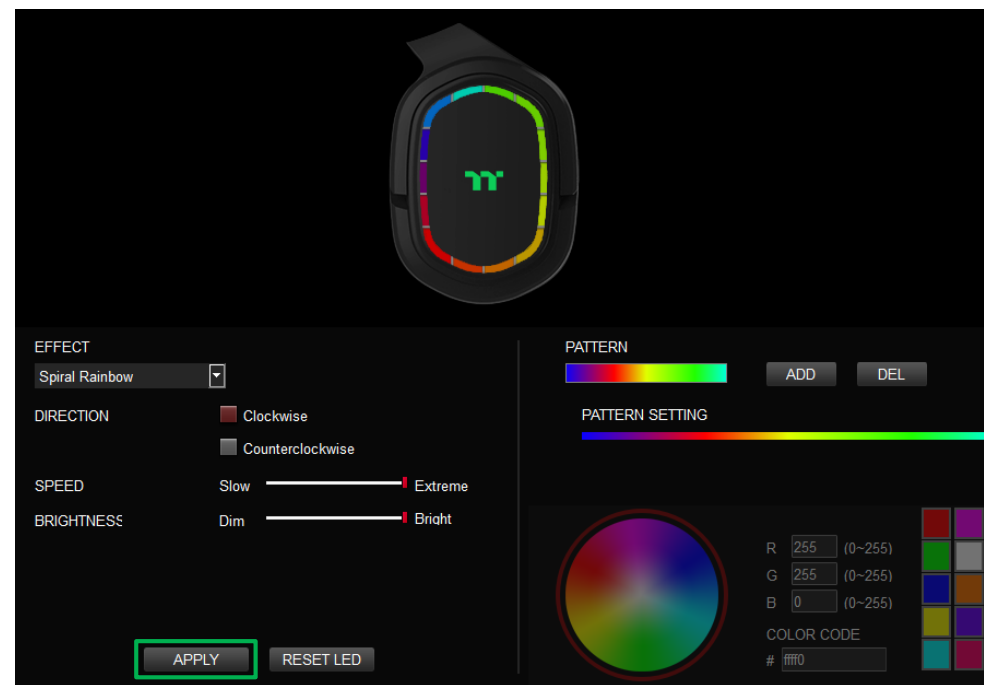



Step 1:

Add a new set of color patterns.

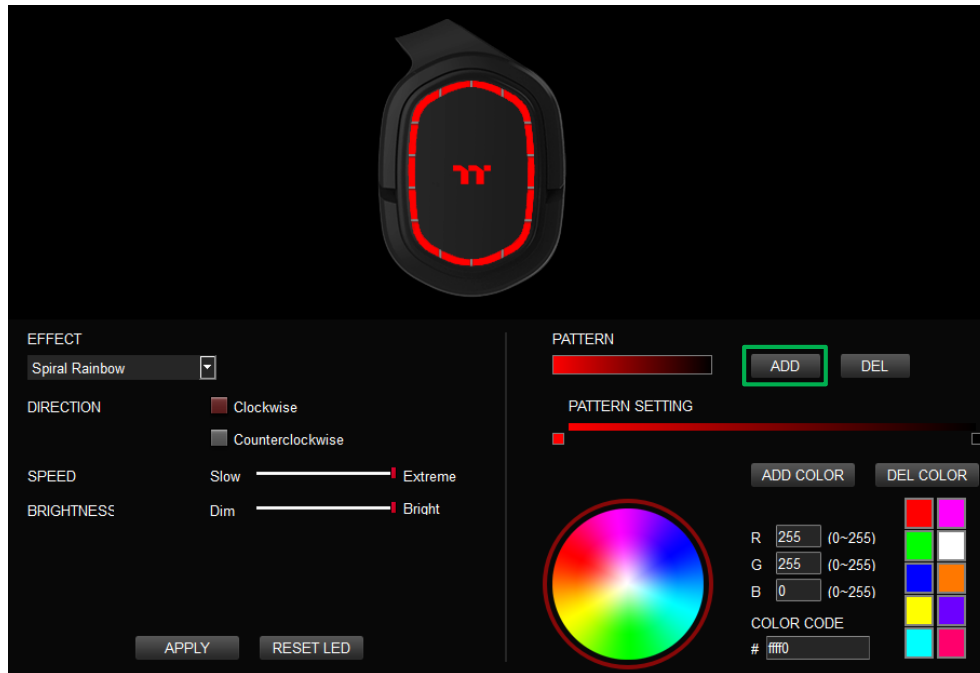

Step 2:

Add a new color-insertion point and drag it to the desired position.

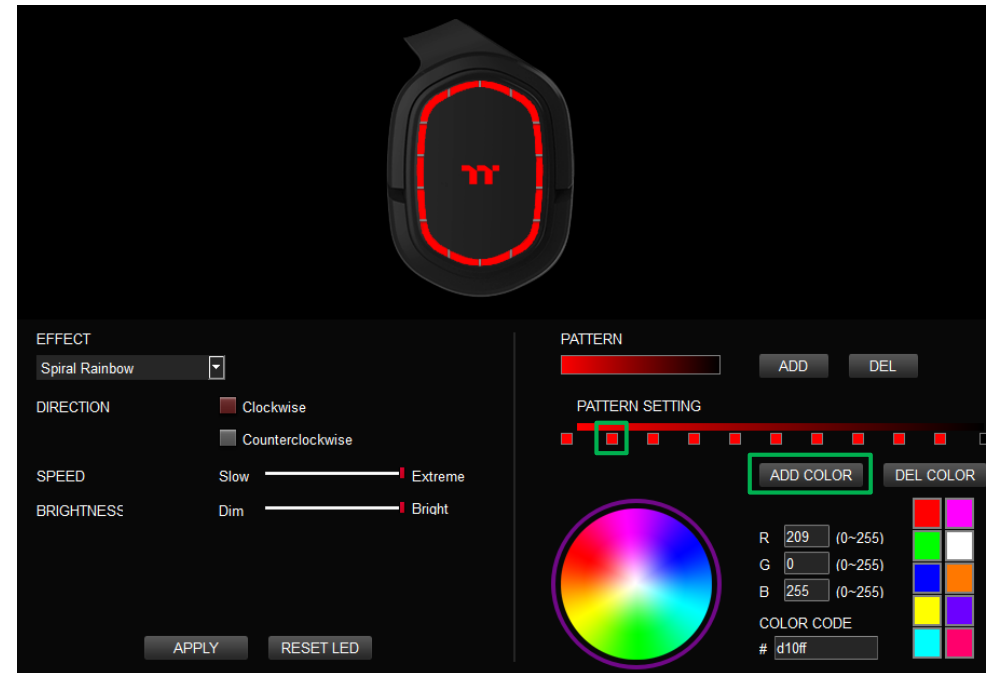



Step 3:

Click on each color-insertion point to modify its color.

Step 4:

Click Apply to save the new settings.

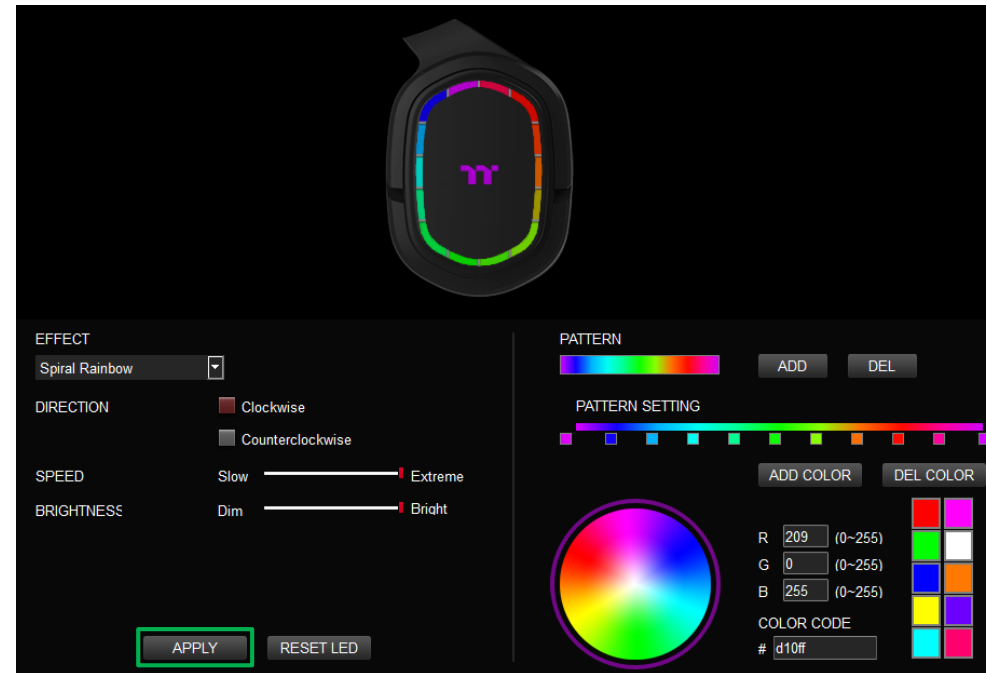
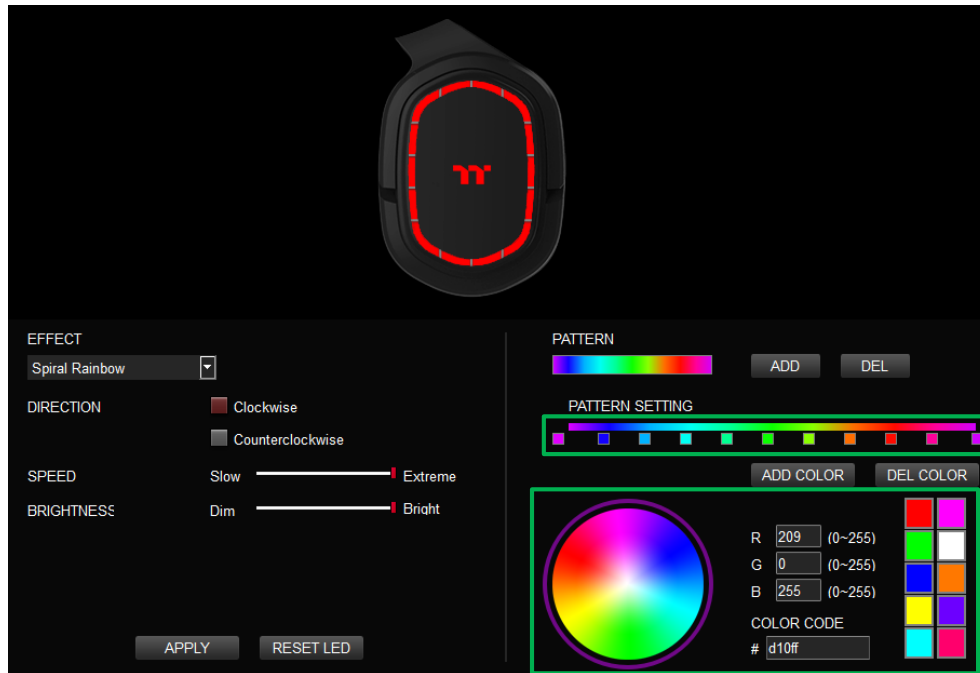



Step 1:

Select "RGB Spectrum" in the Lighting Effect drop-down list.

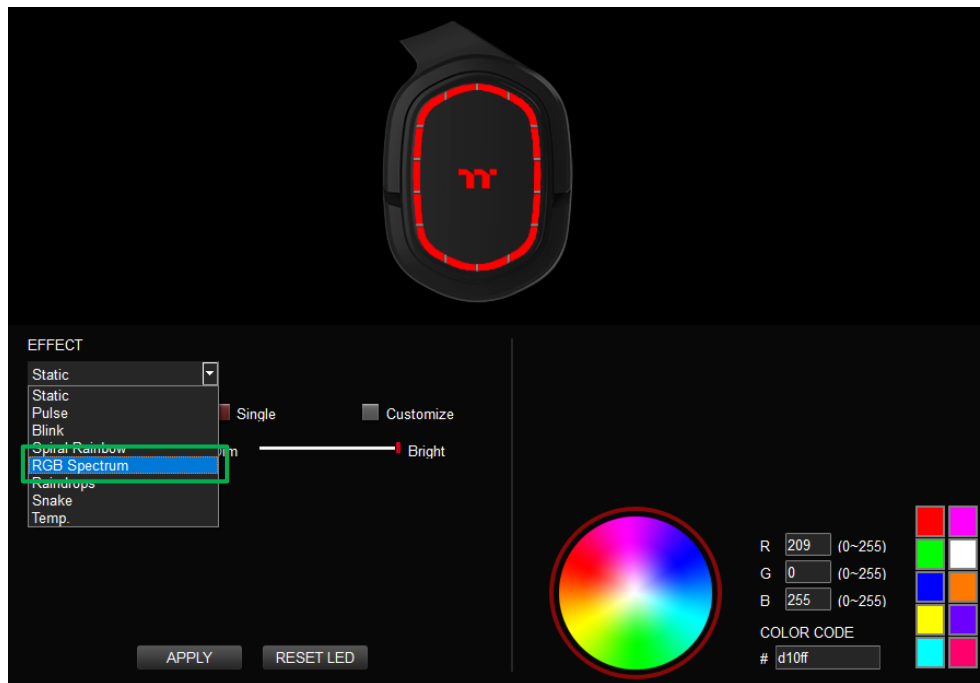

Step 2:

Set the speed and brightness level of the backlight and click on Apply to save the new settings.

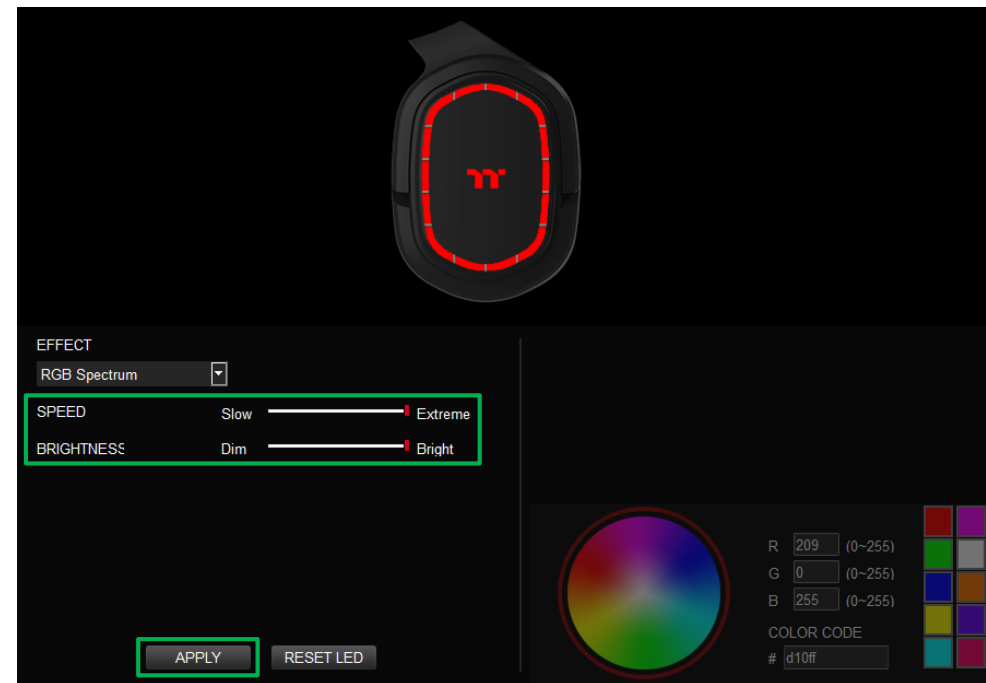



Step 1:

Select "Raindrops" in the Lighting Effect drop-down list.

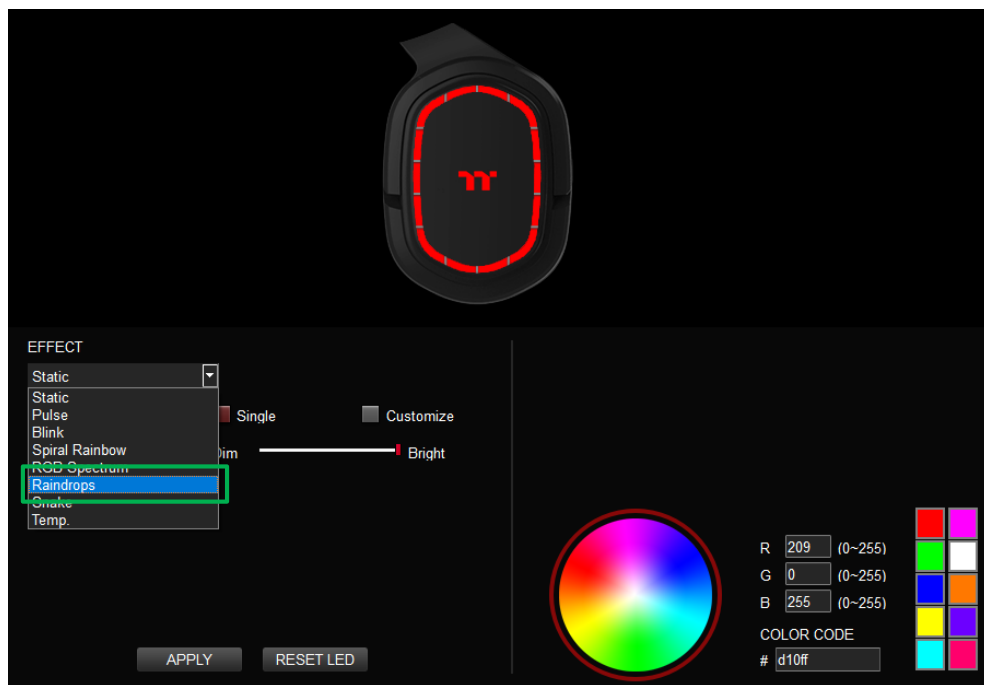

Step 2:

Click on a color inside the color wheel or enter the RGB color values to change the color.

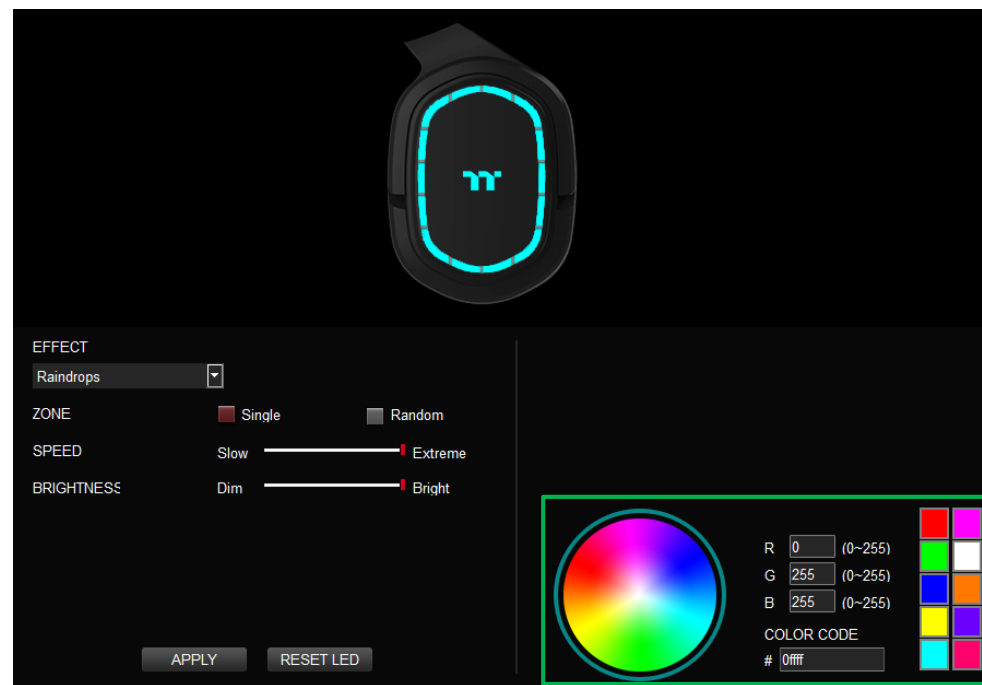



Step 3:

Set the speed and brightness level of the backlight.

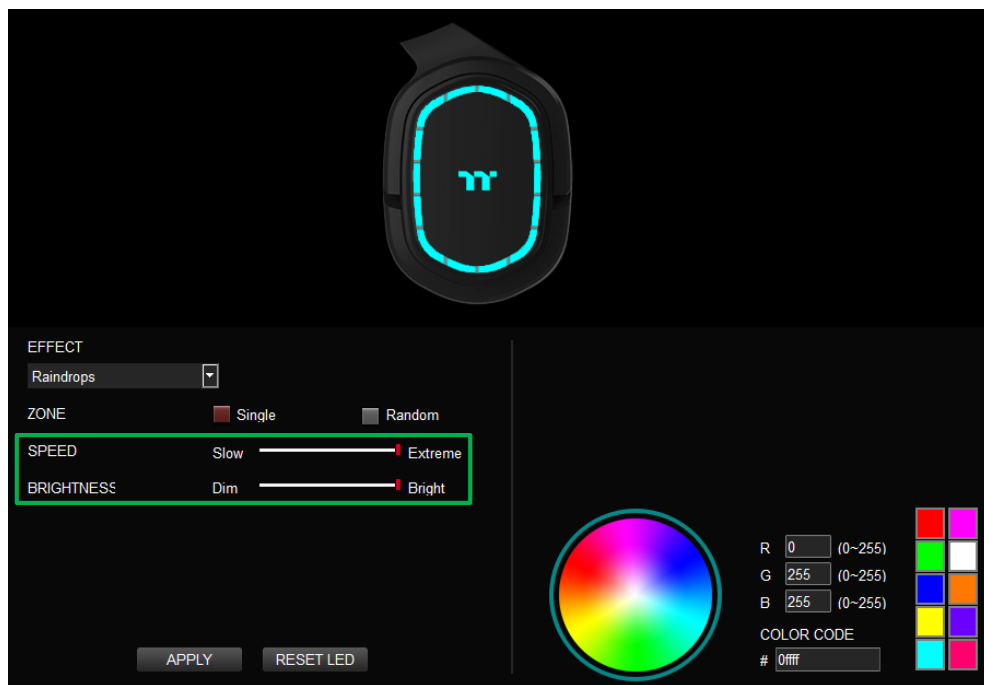

Step 4:

Click Apply to save the new settings.

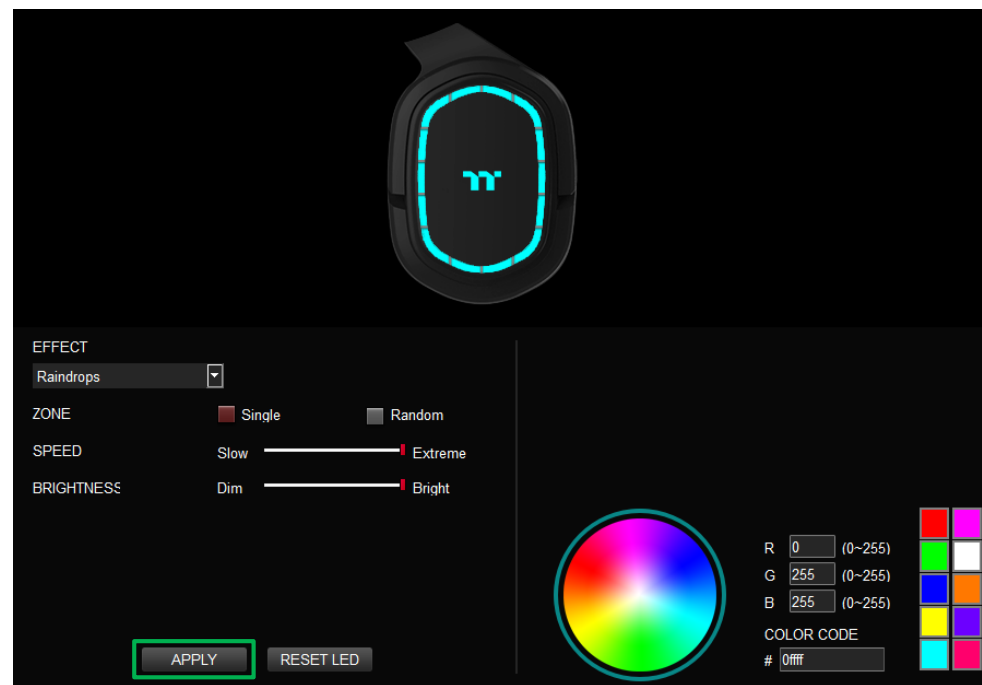

Step 1:

Select "Snake" in the Lighting Effect drop-down list.

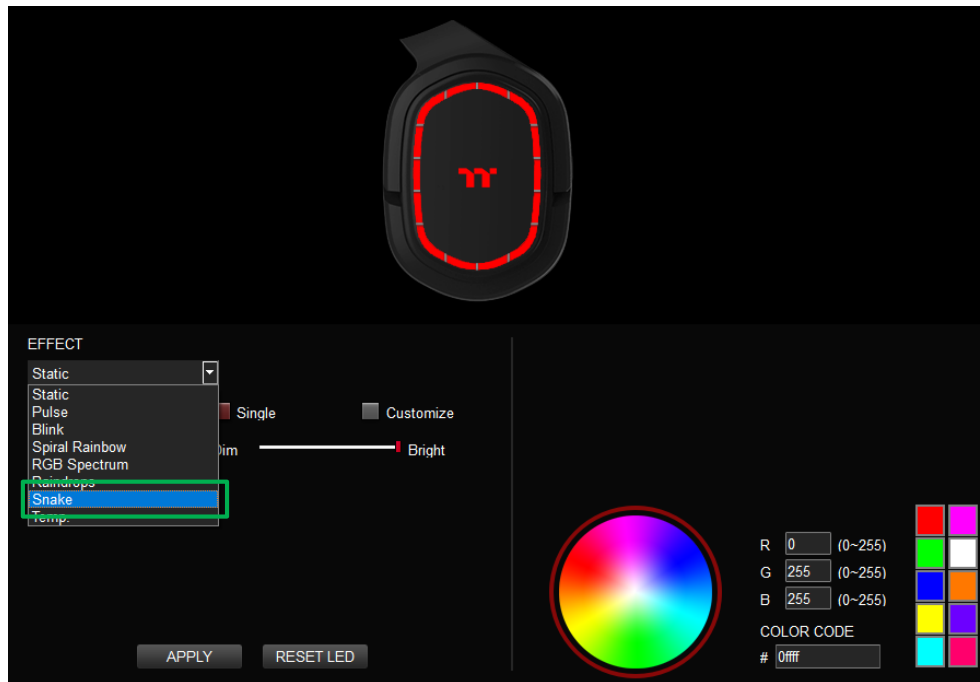

Step 2:

Click on a color inside the color wheel or enter the RGB color values to change the color.

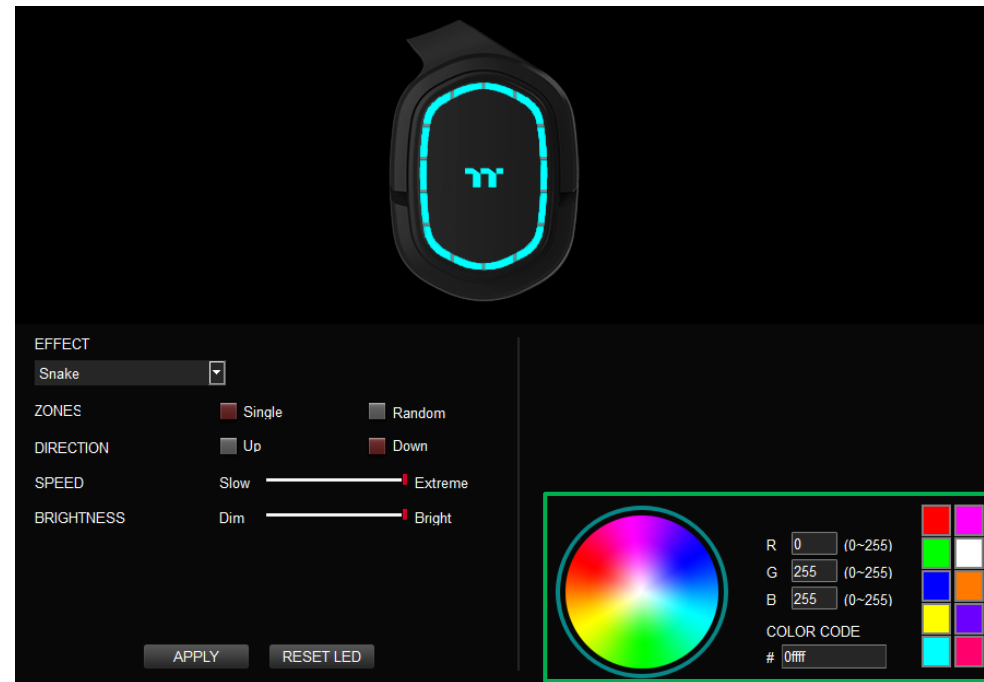

Step 3:

Set the direction, speed, and brightness level of the lighting effect.

Step 4:

Click Apply to save the new settings.

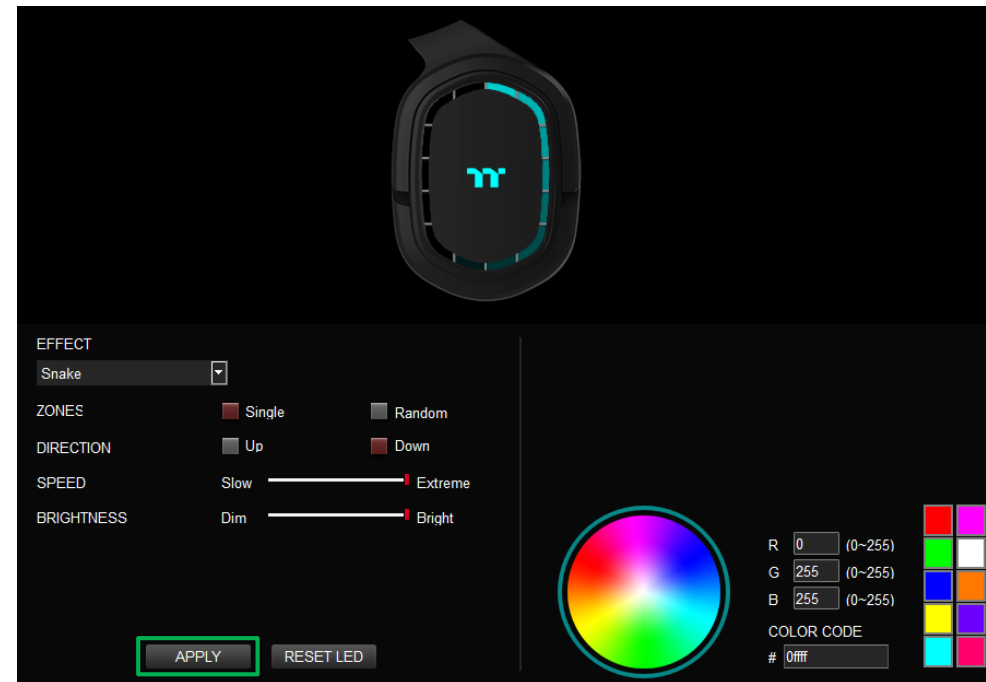
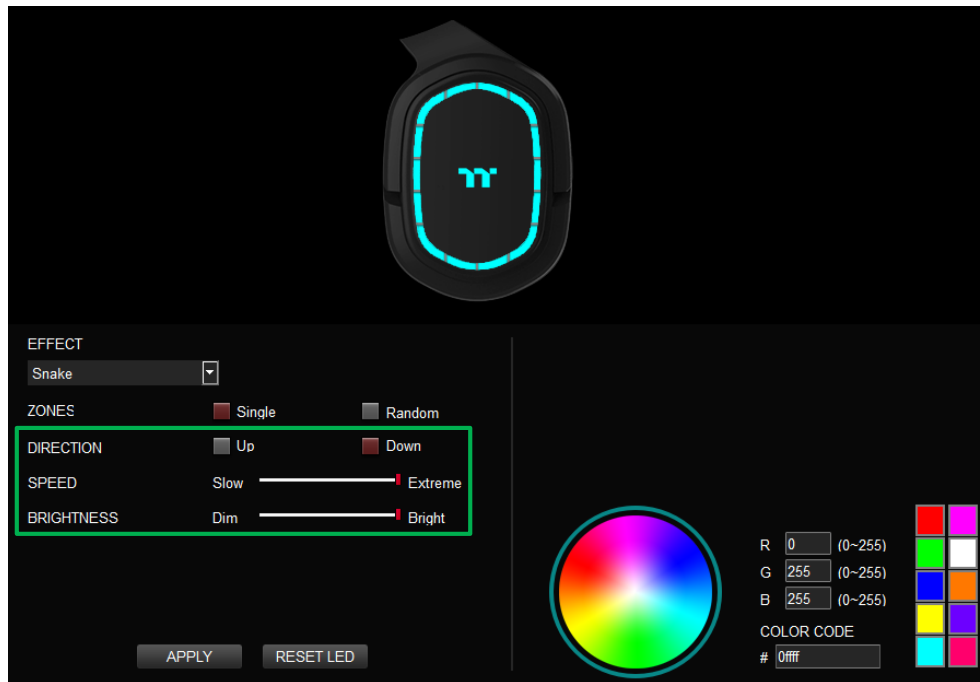



Step 1:

Select "Temperature" in the Lighting Effect drop-down list.

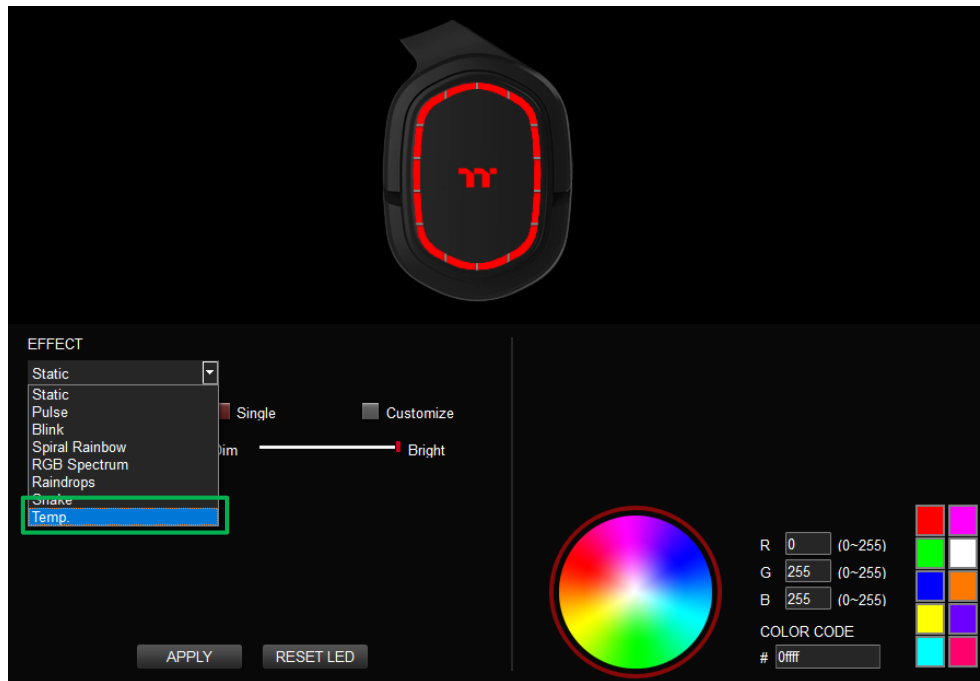

Step 2:

Click Apply to save the new settings.

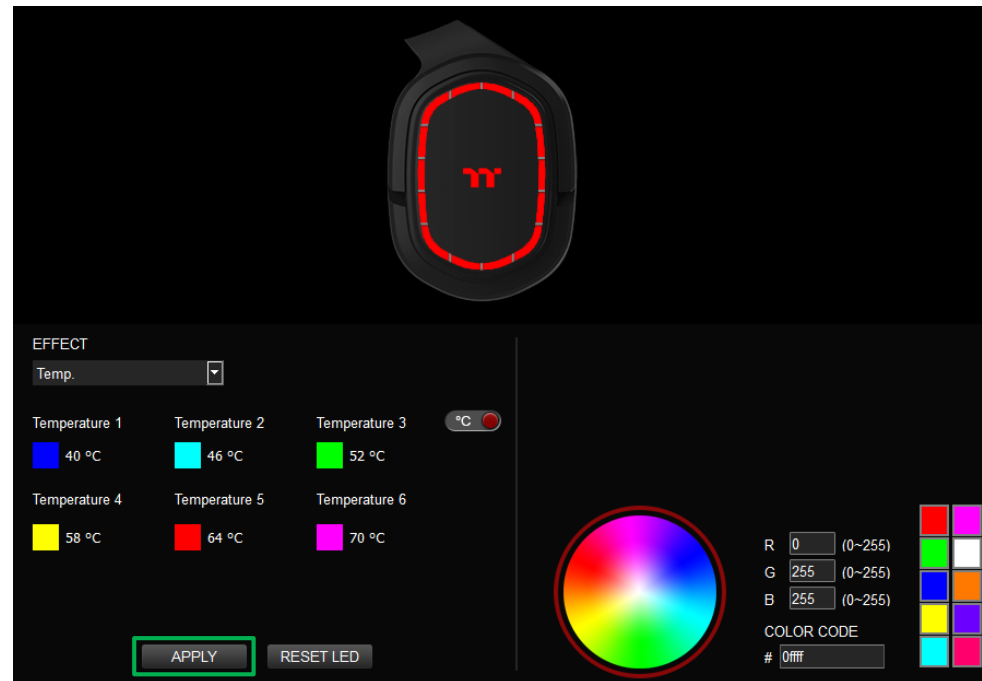

| Chapter 5 : FUNCTIONS AVAILABLE ON THE SPEAKER PAGE



DTS Sound Unbound Download

Click icon to download DTS Sound Unbound (refer to page 49).

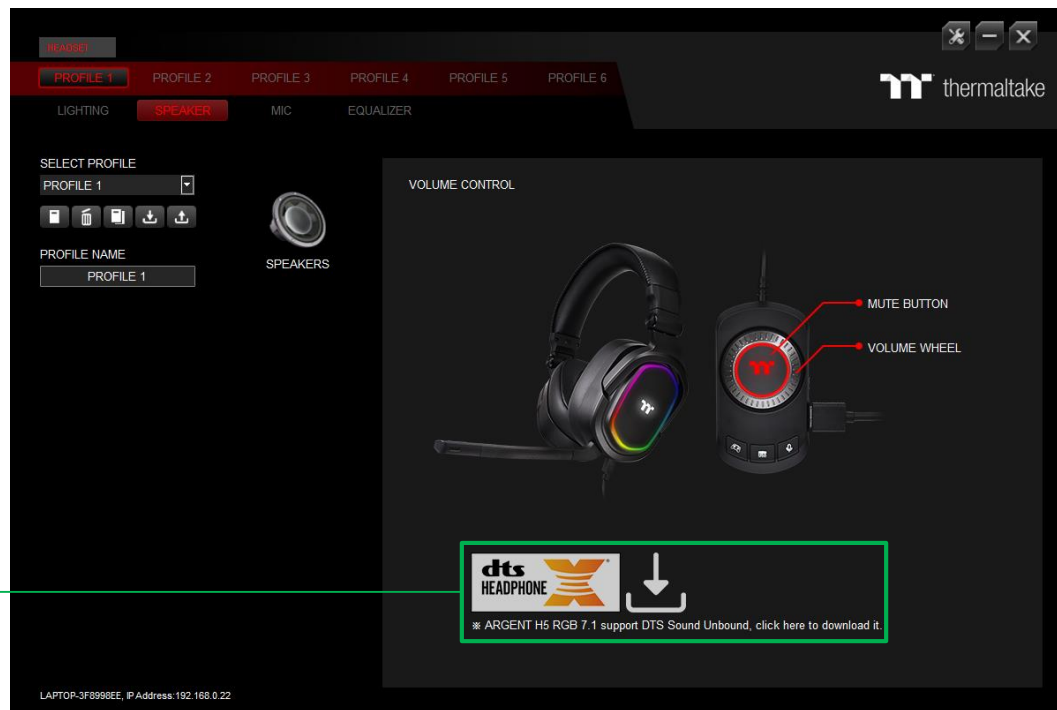

| Chapter 6 : FUNCTIONS AVAILABLE ON THE MIC PAGE

Mic Volume

Adjusts the microphone input or mute the mic.

Sample Rate Settings

16 Bit Support: 44.1 KHz 、 48 KHz 、 88.2 KHz 、 96 KHz.

24 Bit Support: 44.1 KHz 、 48 KHz 、 88.2 KHz 、 96 KHz.

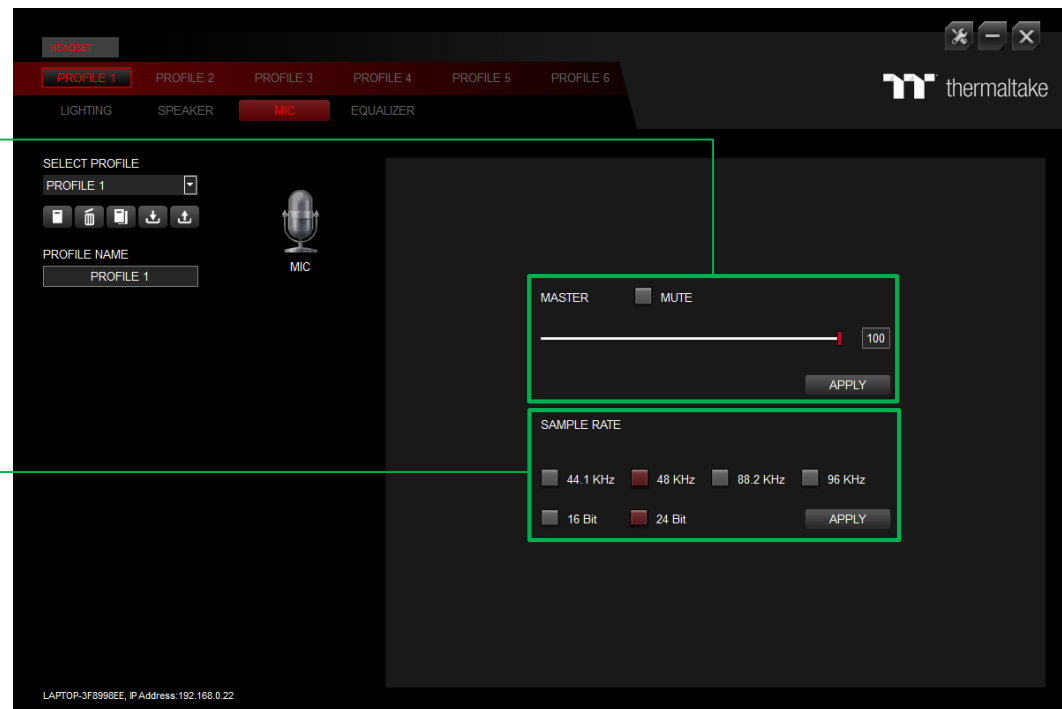

| Chapter 7 : FUNCTIONS AVAILABLE ON THE EQUALIZER PAGE

Audio Equalizer

Manually adjusting any equalizer preset will automatically set it to Custom.

✂ Equalizer only available on Headphones (ARGENT H5 RGB 7.1).

Audio Equalizer Settings

Support Four Equalizer Presets: FPS、MMORPG、ARPG、RTS.

Support Four Customized Presets: Default 1 - 4.

Apply / Restore Equalizer Settings

Apply: Apply the new equalizer settings on the headset.

Restore Equalizer Settings: All equalizer settings saved under the current profile will be restored to factory default values.



| Chapter 8 : FUNCTIONS AVAILABLE ON THE SETTINGS PAGE

Language Settings

Sets the language of the program's user Interface and theme.

Razer Chroma On / OFF

Users who have installed both the TT iTAKE Software and Razer Synapse 3 can experience synchronized gaming and RGB lighting effects on their gaming gear.

Amazon Alexa Login

TT iTAKE software support Amazon Alexa voice service, allowing you to control the lights by talking to the Alexa Enabled device.

TT iTAKE APP Password Setting

Enter four number or English alphabet.

✘ Empty is disable function.

Official Website / Social Media

Official Website: Visit the Product official website.

Social Media: Visit Thermaltake on Facebook.

Software Version

Software Version: Displays the version number of the installed program.

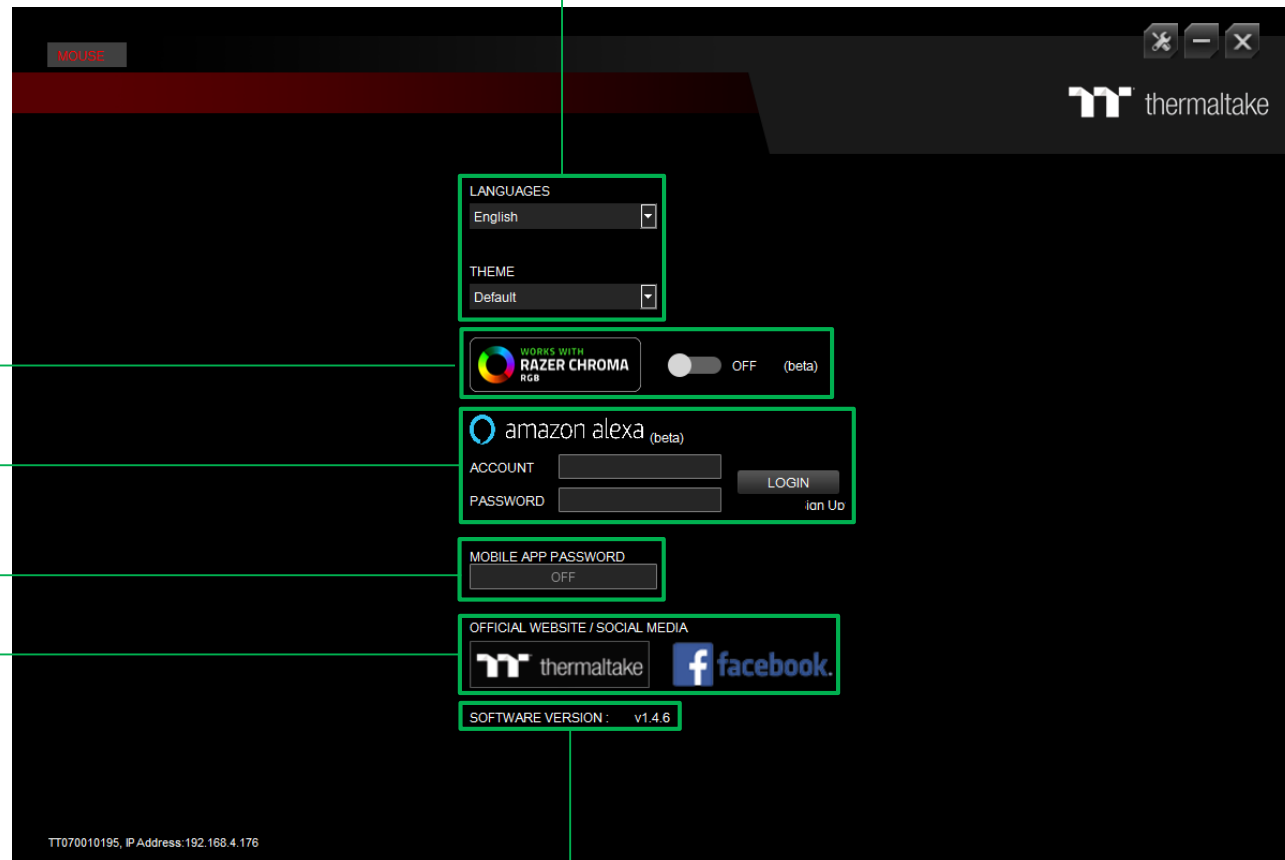

| Chapter 9 : DTS SOUND UNBOUND INSTALLATION

Step 1 :

Open the Microsoft store from the start menu.

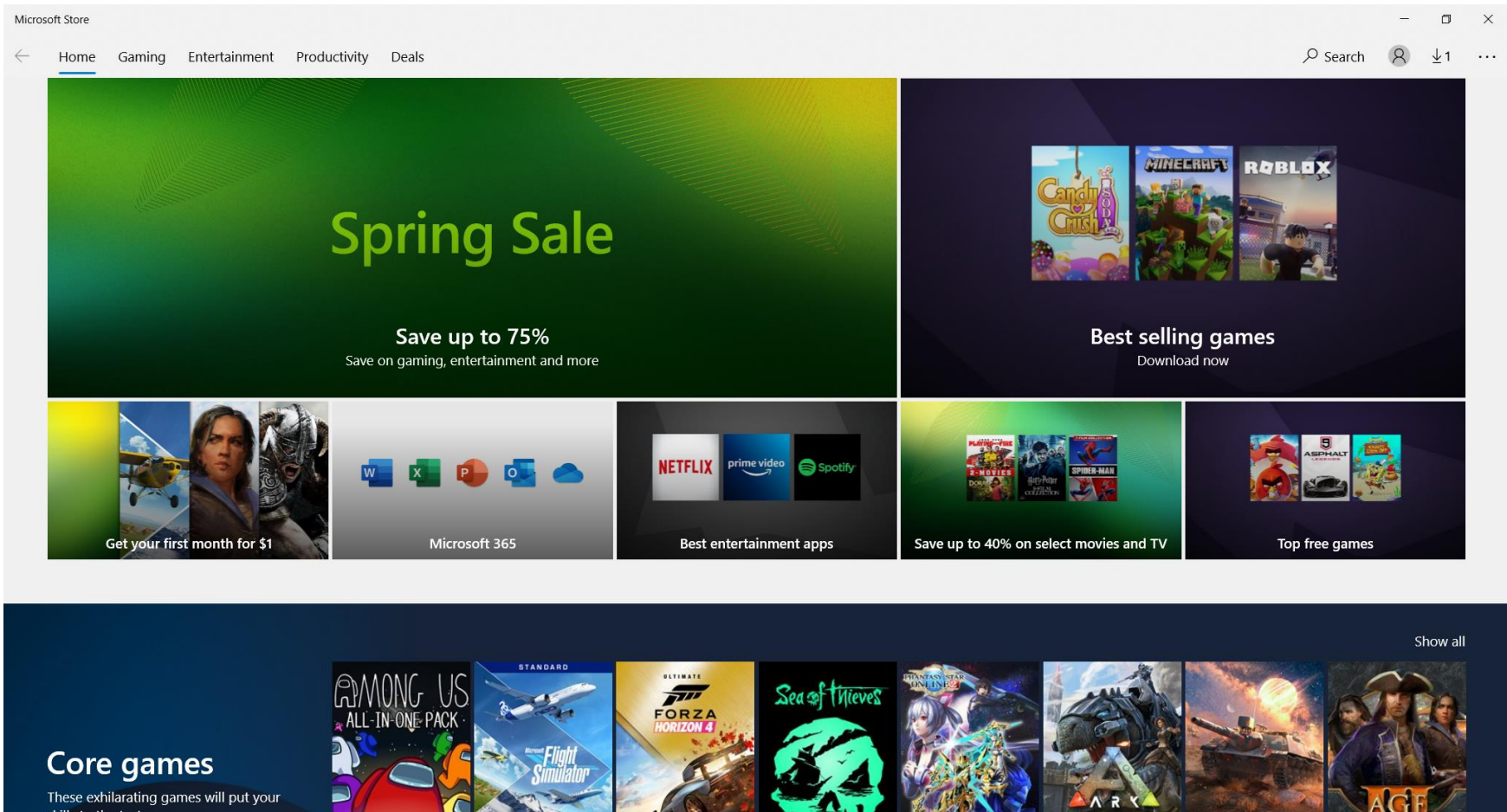

※ DTS Sound Unbound only available on Windows 10.

Step 2 :

Enter "DTS Sound Unbound" into the search bar.

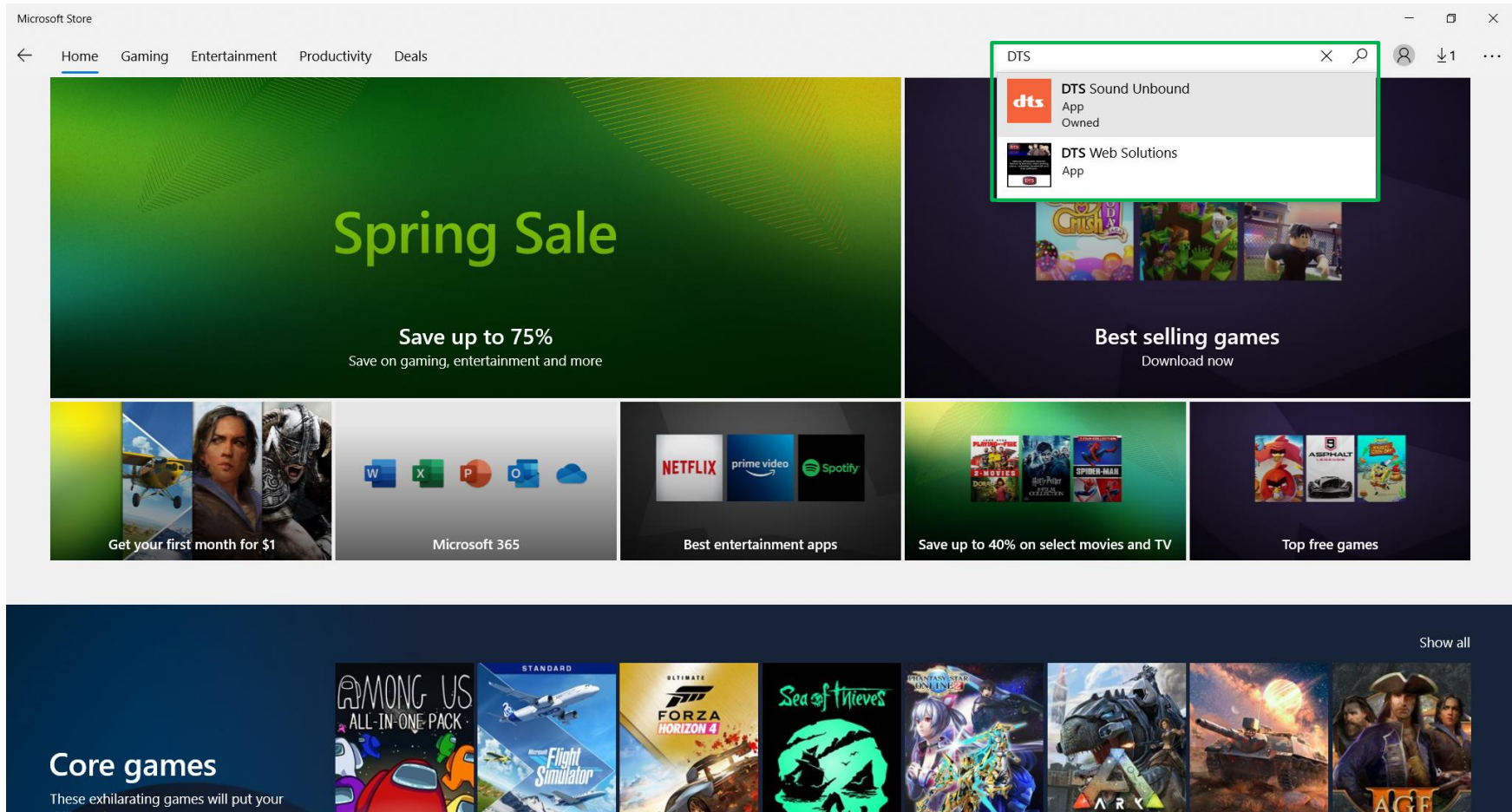



Step 3 :

Tap to install.

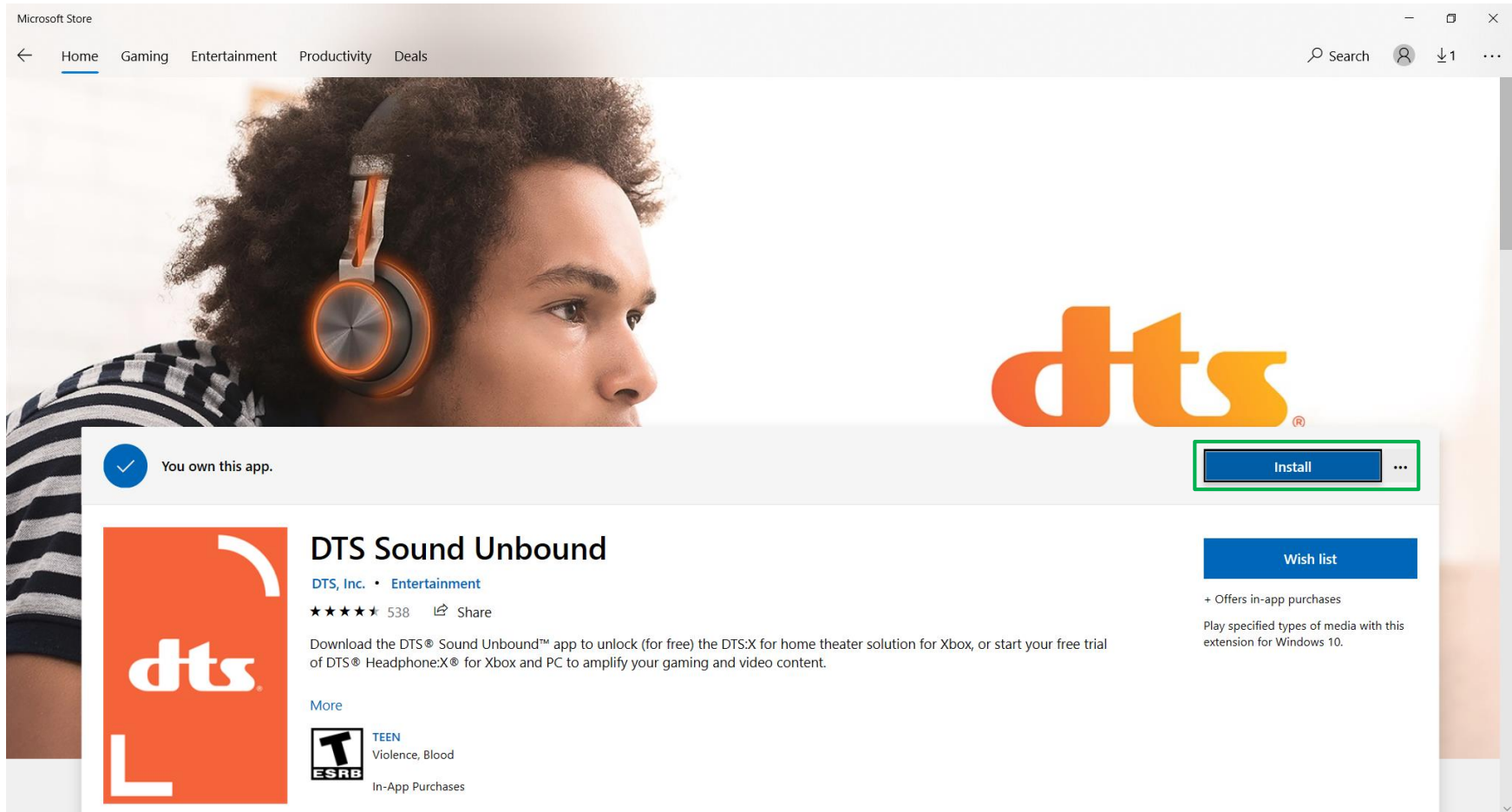



Step 1 :

Left click speaker icon and select "Headset Earphone (ARGENT H5 RGB 7.1)" and open the DTS Sound Unbound from start menu.

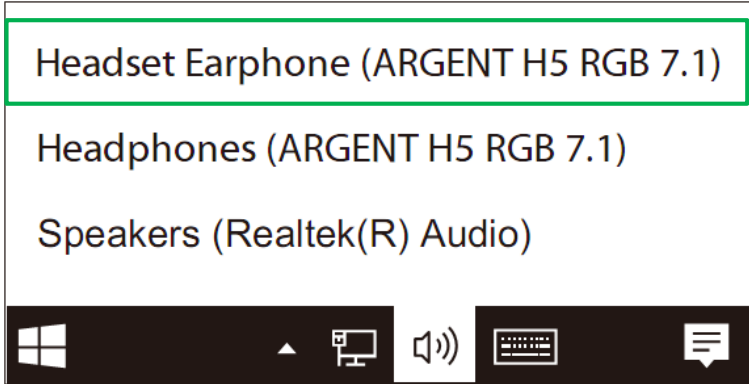

※ DTS Sound Unbound only available on Headset Earphone (ARGENT H5 RGB 7.1) used.

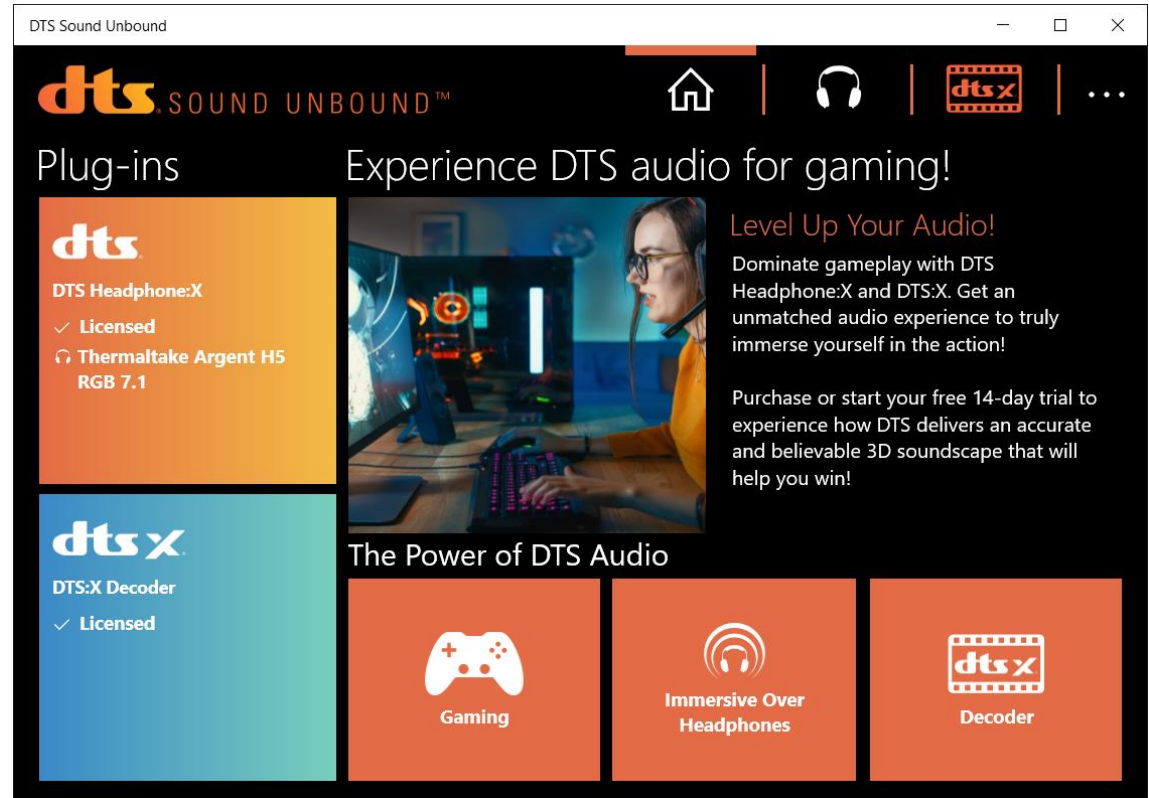

Step 2 :

Select headset icon and enable DTS Headphone:X.

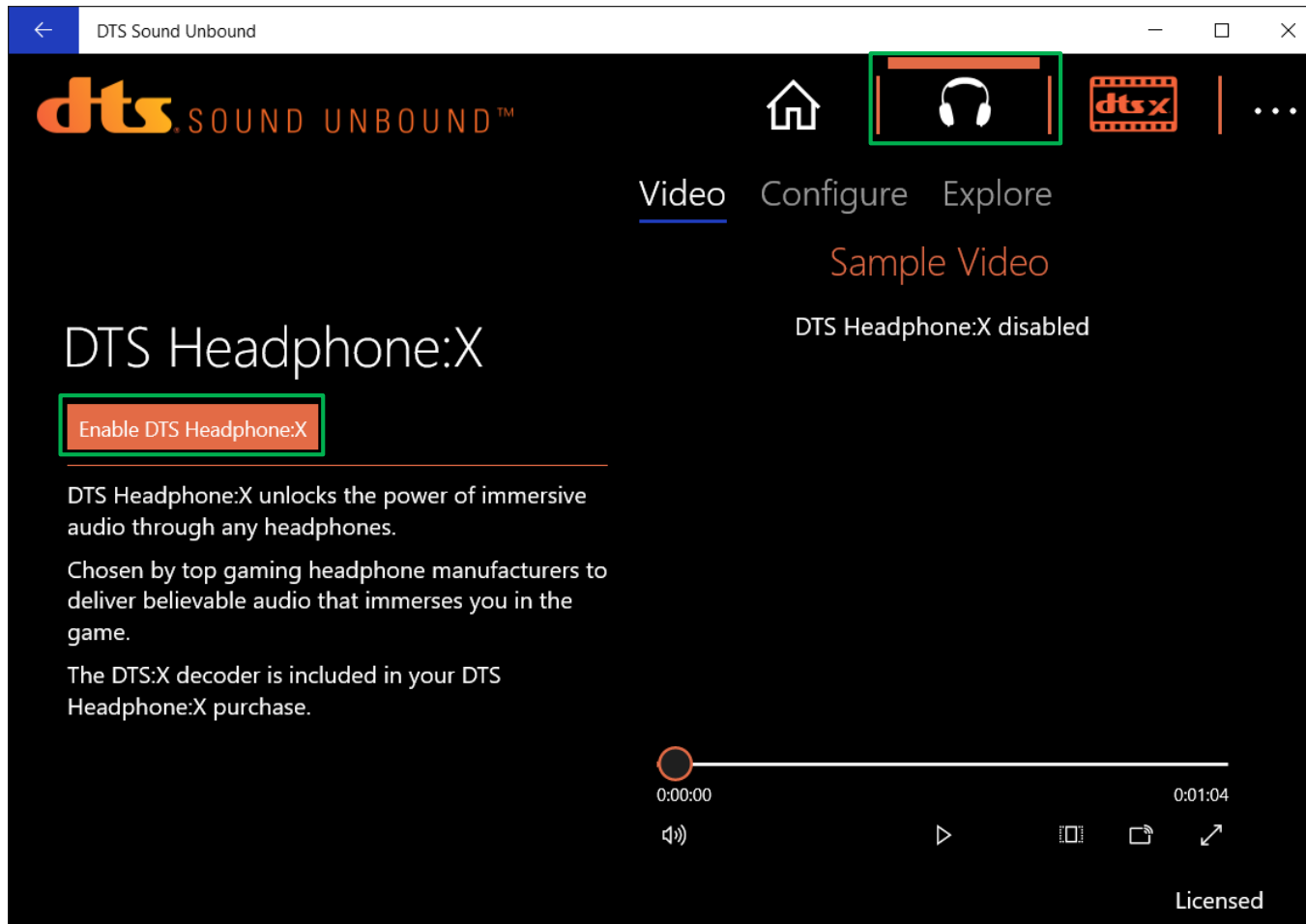

Step 3 :

Select the configure and search "ARGENT H5 RGB 7.1".

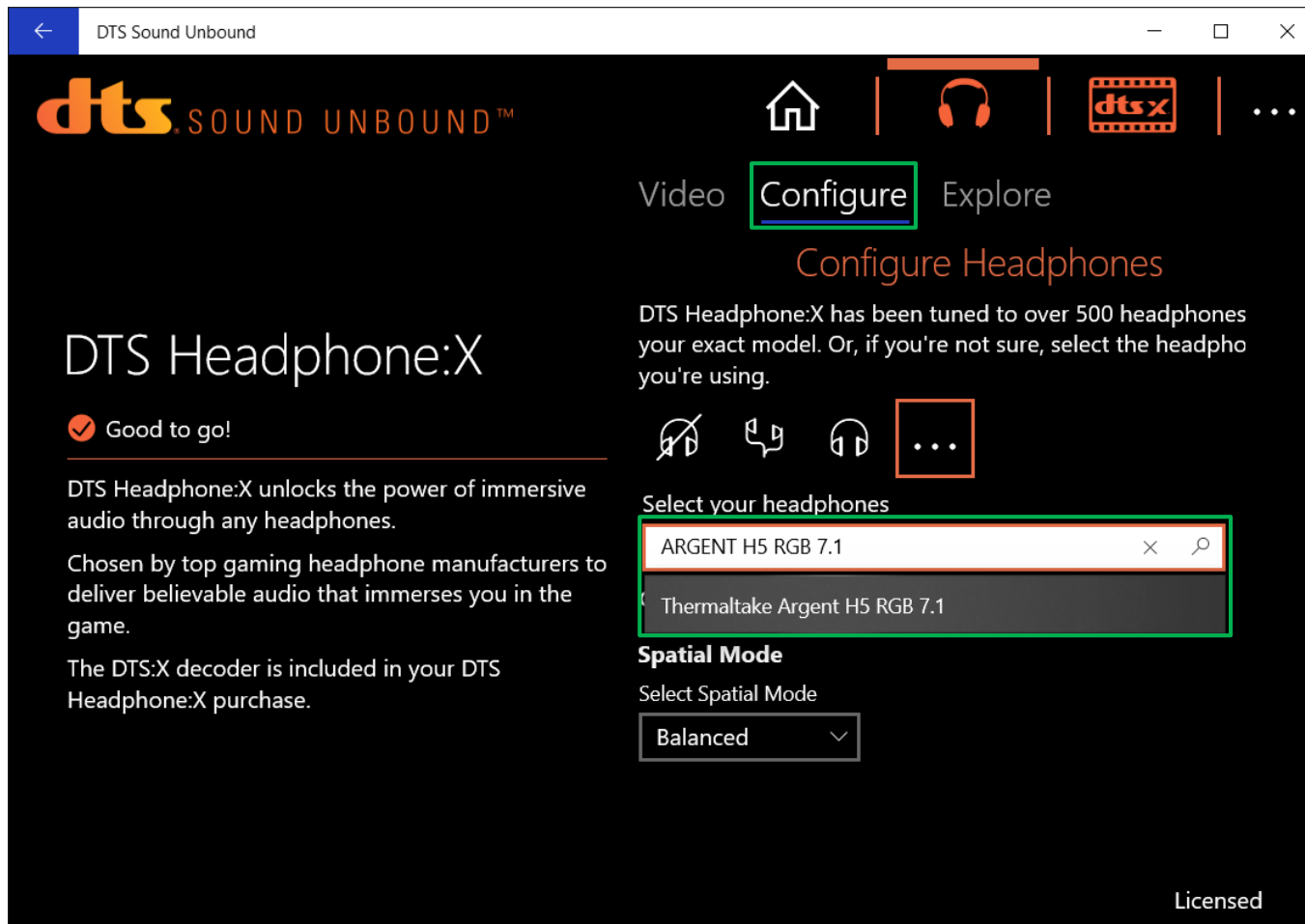

Step 4 :

Select the spatial mode and switch to spacious.

