

# Tefal®

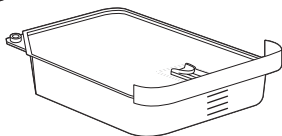

## Oleoclean Compact Fryer

[www.tefal.com](http://www.tefal.com)

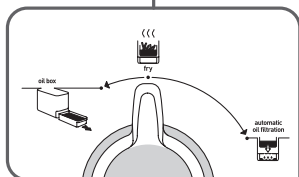
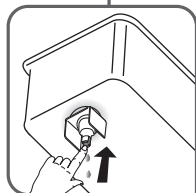
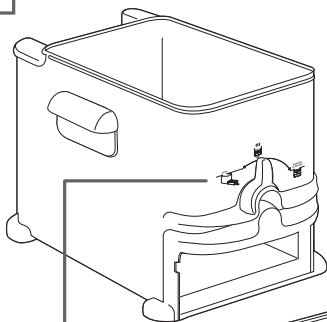
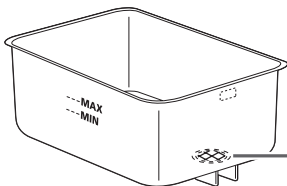
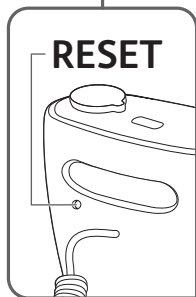
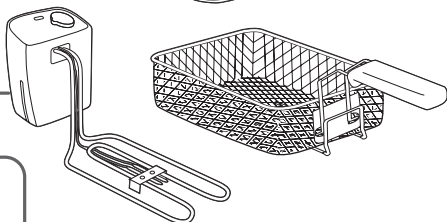
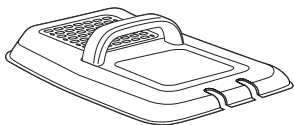

1

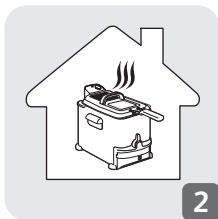
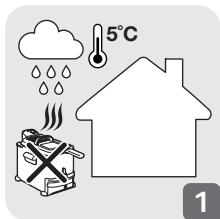

2

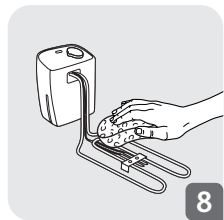
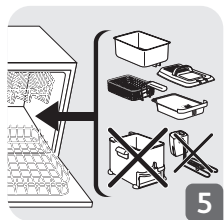
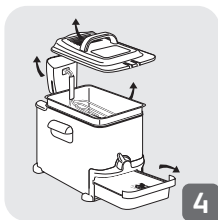
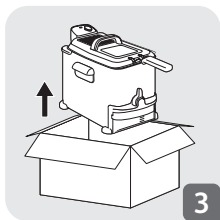

3

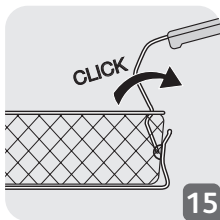
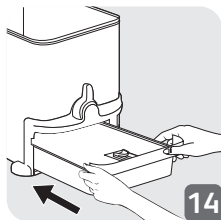
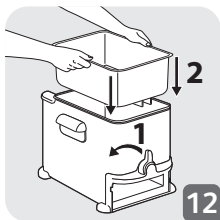
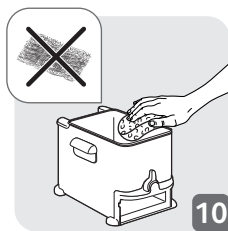
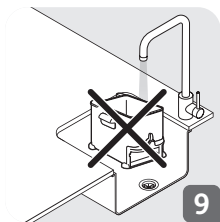

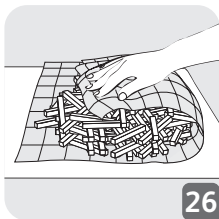
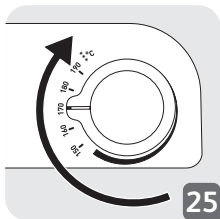
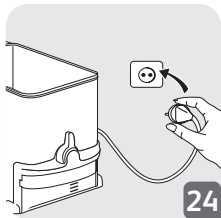
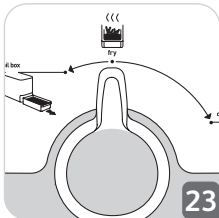
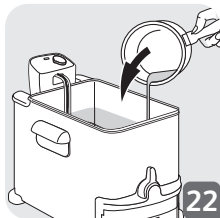
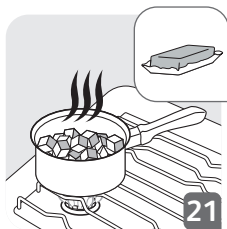
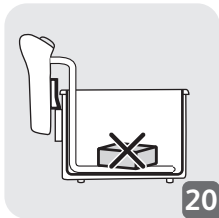
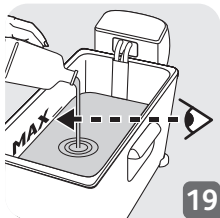

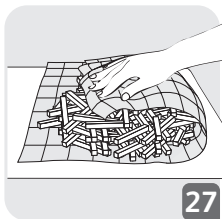

27



28

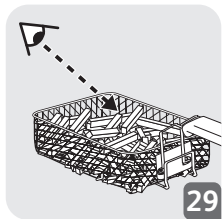

29

\*\*\*



30



31

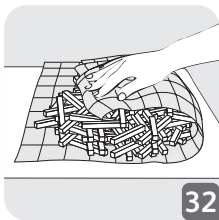

32



33

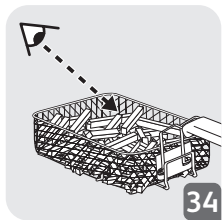

34

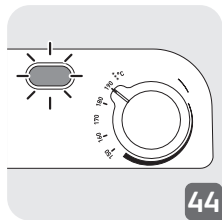
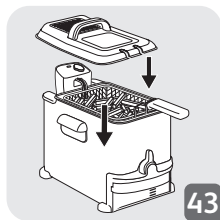
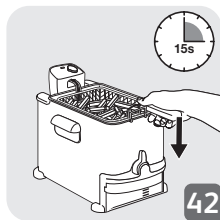
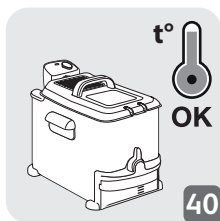
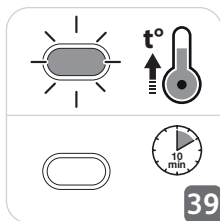
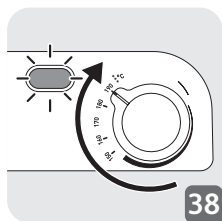
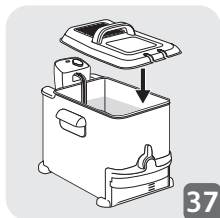
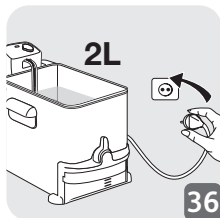

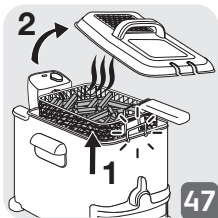



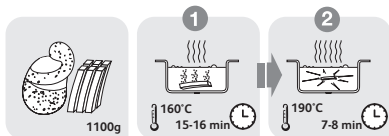





6



	Nb		 °C	
		1100 g	① 160°C	15-16 min
			② 190°C	7-8 min
		600 g	190°C	10-12min
		400 g	160°C	5-6 min
	4		190°C	5-6 min
	6		170°C	6-8 min
		400 g	150°C	8-10 min

8



	Nb			
		550 g	190°C	9-11 min
		800 g	190°C	8-10 min
		350 g	190°C	6-7 min
	15		190°C	4-5 min

7

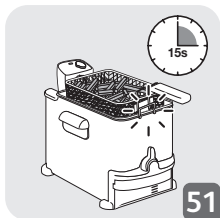
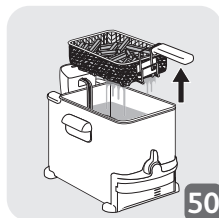
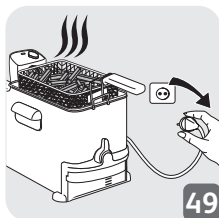
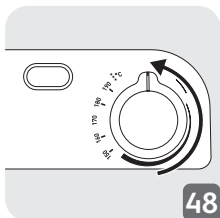

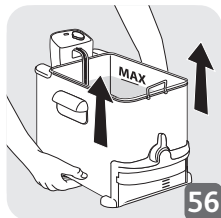
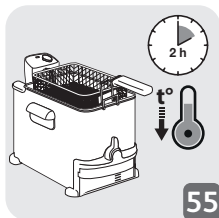

8

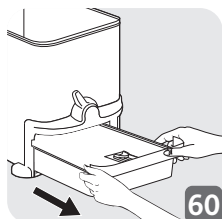
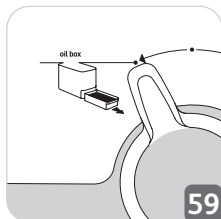
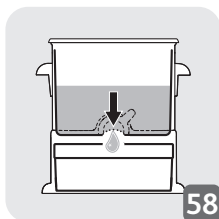
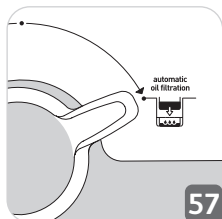
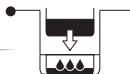

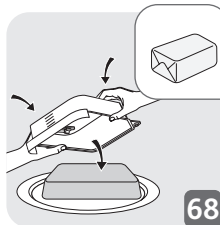
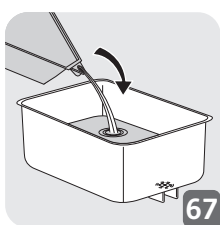
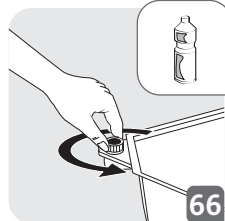
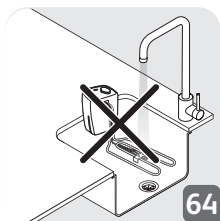
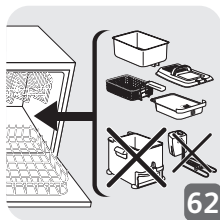
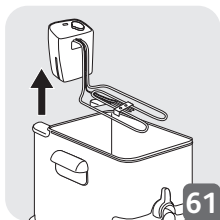

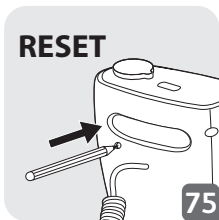
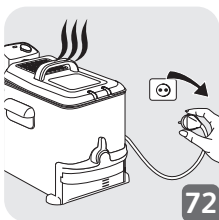
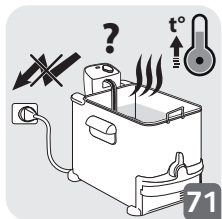
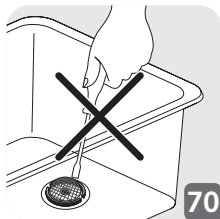
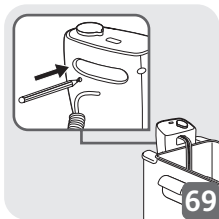

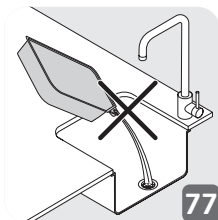

NC00142036